

JVC

SERVICE MANUAL

LINEAR TRACKING FULLY-AUTOMATIC TURNTABLE

MODEL L-E50B



Contents

	Page		Page
Safety Precautions	1- 1	9. Rope Suspension	1-10
1. Features	1- 2	10. Block Diagram	1-11
2. Specifications	1- 2	11. Check of Power Supply P.C. Board	1-11
3. Controls and Functions	1- 3	12. Adjustment Procedures	1-12
4. Service Precautions	1- 5	12-(1) Offset Adjustment	1-12
5. Technical Explanation	1- 5	12-(2) Track Interval (Marker Space) Detection Sensor Sensitivity Adjustment	1-12
5-(1) Programmed Playback	1- 5	12-(3) Lead-In Adjustment	1-12
5-(2) Explanation of Microprocessor Pins	1- 6	12-(4) Motor Speed Adjustment	1-12
6. Stylus Replacement	1- 8	12-(5) Program Position (Touch-Down Position) Adjustment	1-12
6-(1) Removal	1- 8	13. Connection Diagram	1-13
6-(2) Attachment	1- 8	14. Power Cord Connections in Different Areas	1-14
7. Cartridge Replacement	1- 8	15. Troubleshooting	1-15
8. Removal Procedures	1- 9	16. L-E50B Schematic Diagram	1-18
8-(1) Disassembly Procedures	1- 9	Parts List	Separate-volume Insertion
8-(2) Removal and Attachment of Platter Compartment Door	1-10		

Safety Precautions

1. The design of this product contains special hardware, many circuits and components specially for safety purposes.
For continued protection, no changes should be made to the original design unless authorized in writing by the manufacturer. Replacement parts must be identical to those used in the original circuits. Service should be performed by qualified personnel only.
2. Alterations of the design or circuitry of the product should not be made. Any design alterations or additions will void the manufacturer's warranty and will further relieve the manufacturer of responsibility for personal injury or property damage resulting therefrom.
3. Many electrical and mechanical parts in the product have special safety-related characteristics. These characteristics are often not evident from visual inspection nor can the protection afforded by them necessarily be obtained by using replacement components rated for higher voltage, wattage, etc. Replacement parts which have these special safety characteristics are identified in the parts list of Service manual. Electrical components having such features are identified by shading on the schematics and by (Δ) on the parts list in Service manual. The use of a substitute replacement which does not have the same safety characteristics as the recommended replacement part shown in the parts list in Service manual may create shock, fire, or other hazards.
4. The leads in the products are routed and dressed with ties, clamps, tubings, barriers and/or the like to be separated from live parts, high temperature parts, moving parts and/or sharp edges for the prevention of electric shock and fire hazard.
When service is required, the original lead routing and dress should be observed, and they should be confirmed to be returned to normal, after re-assembling.

5. Leakage current check

(Safety for electrical shock hazard)

After re-assembling the product, always perform an isolation check on the exposed metal parts of the Products (antenna terminals, knobs, metal cabinet, screw heads, headphone jack, control shafts, etc.) to be sure the product is safe to operate without danger of electrical shock.

Do not use a line isolation transformer during this check.

- Plug the AC line cord directly into the AC outlet. Using a "Leakage Current Tester", measure the leakage current from each exposed metal part of the cabinet, particularly any exposed metal part having a return path to the chassis, to a known good earth ground. Any leakage current must not exceed 0.5 mA AC (r.m.s.).
- Alternate check method
Plug the AC line cord directly into the AC outlet. Use an AC voltmeter having 1,000 ohms per volt or more sensitivity in the following manner. Connect a 1500 Ω 10 W resistor paralleled by a 0.15 μ F AC-type capacitor between an exposed metal part and a known good earth ground. Measure the AC voltage across the resistor with the AC voltmeter.
Move the resistor connection to each exposed metal part, particularly any exposed metal part having a return path to the chassis, and measure the AC voltage across the resistor. Now, reverse the plug in the AC outlet and repeat each measurement. Any voltage measured must not exceed 0.75 V AC (r.m.s.). This corresponds to 0.5 mA AC (r.m.s.).

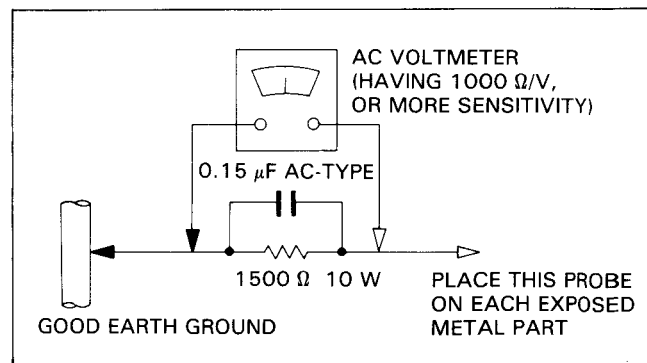

CHECKING YOUR LINE VOLTAGE (For U.S. Military Market and Other Countries)

Before inserting the power plug, please check this setting to see that it corresponds with the line voltage in your area. If it doesn't, be sure to adjust the voltage selector switch to the proper setting before operating this equipment. The voltage selector switch is located bottom board.

CAUTION Before selecting the "Voltage selector switch" to proper voltage disconnect the power plug.

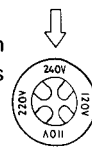

1. Features

- Linear tracking for zero tracking error
- Computer-supervised fully automatic operation
- Random programming of 8 tracks for up to 15 plays
- Index play for sampling intros
- Automatic record size-selection/presence detection
- Plug-in cartridge connector

2. Specifications

MOTOR AND PLATTER

Drive Motor : DC servomotor
 Drive System : Belt drive
 Speeds : 33-1/3 rpm and 45 rpm
 Wow and Flutter : 0.07% (DIN)
 S/N Ratio : 70 dB (DIN-B)

Load Impedance : 47 kohms
 Tracking Ability : 70 μ m at 315 Hz
 Compliance : 9×10^{-6} cm/dyne (dynamic)
 Stylus : 0.6 mil conical stylus (diamond)
 Stylus Replacement : DT-45
 Tracking Force : 1.25 g

TONARM

Type : Linear tracking statically
 balanced low-mass straight arm
 Effective Length : 105 mm
 Tracking Error : + 15'

General

Dimensions : 340(W) \times 108(H) \times 356(D) mm
 (Since the dimensions show only the design measurements, an allowance is required when installing the unit in a limited space such as a rack, etc.)
 Weight : 7.8 kg (NET)

CARTRIDGE

Type : MD-1045
 Principle : Moving magnet (MM)
 Frequency Response : 20 Hz ~ 25,000 Hz
 Output : 2.5 mV (1 kHz 50 mm/s)
 Channel Separation : 25 dB/1 kHz (Test record: TRS-1)

Design and specifications subject to change without notice.

POWER SPECIFICATIONS

Countries	Line Voltage & Frequency	Power Consumption
CONTINENTAL EUROPE	AC 220 V \sim , 50 Hz	15 watts
U.K. & AUSTRALIA	AC 240 V \sim , 50 Hz	
U.S. MILITARY MARKET	AC 110/120/220/240 V \sim selectable, 50/60 Hz	
OTHER AREAS	AC 110/120/220/240 V \sim selectable, 50/60 Hz	

3. Controls and Functions

1 POWER

Press this button to apply power to the unit. The SPEED indicator lights up, indicating that power is on. To switch the unit off, press this button once more. The SPEED indicator will go out.

- Note:**
- If the POWER switch is depressed while the platter is in the extended position or the tonearm has not returned to its rest, the AC current will not be switched off before the platter is drawn in and the tonearm has returned to its rest position.
 - Even when the POWER switch is off, this turntable consumes a small amount of electricity (1.5 watts). Disconnect the power cord to turn the electricity off completely.
 - This unit has a power consumption of 1.5 W even when the power was turned off by means of the POWER switch. Therefore, if the unit is not to be used for a long time, remove the AC plug from the outlet.

2 SPEED

Set this button according to the speed of the record.

33-1/3 rpm records : set to the "33"

45 rpm records : Set to the "45"

3 Program/Play Indicator

When playback starts, the indicator corresponding to the tune being played is flashing. During programmed playback, the indicators corresponding to the selected tunes are lit and the indicator of the presently playing tune is flashing.

4 SPEED Indicator

RED-33 : When the SPEED selector is set to "33", this indicator lights up in red.

GREEN-45 : When the SPEED selector is set to "45", this indicator lights up in green.

Note: While the tonearm performs Search, these indicators are flashing.

5 < · >

During manual playback, the tonearm can be moved to the left (<) or right (>) with these buttons. The tonearm keeps moving for as long as the button is depressed and stops when the button is released.

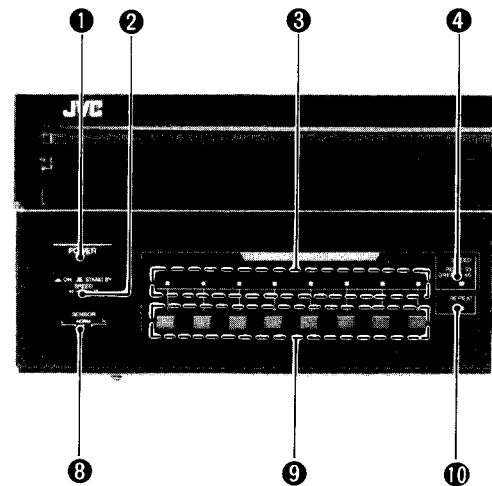

6 UP/DOWN

Pressing this button while the tonearm is raised lowers it and pressing the button while the tonearm is on the disc will raise the tonearm. Use this control for temporary interruption of playback or to lower the tonearm onto the record during manual playback.

7 START/STOP

This button is used to start automatic playback or to interrupt playback of a record. Pressing it during standby initiates "Start" and pressing it during playback initiates "Stop".

Note: Pressing the START/STOP button during repeat playback or programmed playback results in cancellation of the respective operation.

3. Controls and Functions

1 POWER

Press this button to apply power to the unit. The SPEED indicator lights up, indicating that power is on. To switch the unit off, press this button once more. The SPEED indicator will go out.

- Note:**
- If the POWER switch is depressed while the platter is in the extended position or the tonearm has not returned to its rest, the AC current will not be switched off before the platter is drawn in and the tonearm has returned to its rest position.
 - Even when the POWER switch is off, this turntable consumes a small amount of electricity (1.5 watts). Disconnect the power cord to turn the electricity off completely.
 - This unit has a power consumption of 1.5 W even when the power was turned off by means of the POWER switch. Therefore, if the unit is not to be used for a long time, remove the AC plug from the outlet.

2 SPEED

Set this button according to the speed of the record.

- 33-1/3 rpm records : set to the "33"
45 rpm records : Set to the "45"

3 Program/Play Indicator

When playback starts, the indicator corresponding to the tune being played is flashing. During programmed playback, the indicators corresponding to the selected tunes are lit and the indicator of the presently playing tune is flashing.

4 SPEED Indicator

- RED-33 : When the SPEED selector is set to "33", this indicator lights up in red.
GREEN-45: When the SPEED selector is set to "45", this indicator lights up in green.

Note: While the tonearm performs Search, these indicators are flashing.

5 < >

During manual playback, the tonearm can be moved to the left (<) or right (>) with these buttons. The tonearm keeps moving for as long as the button is depressed and stops when the button is released.

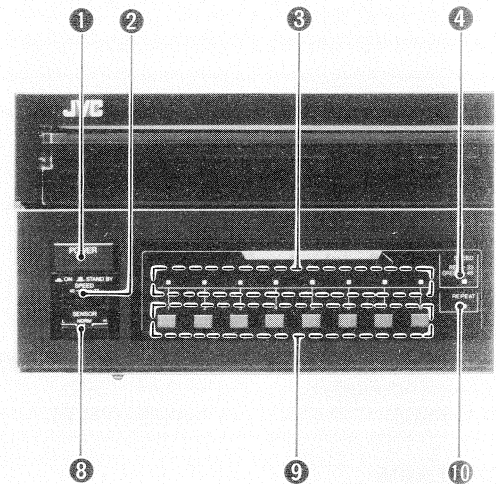

6 UP/DOWN

Pressing this button while the tonearm is raised lowers it and pressing the button while the tonearm is on the disc will raise the tonearm. Use this control for temporary interruption of playback or to lower the tonearm onto the record during manual playback.

7 START/STOP

This button is used to start automatic playback or to interrupt playback of a record. Pressing it during standby initiates "Start" and pressing it during playback initiates "Stop".

Note: Pressing the START/STOP button during repeat playback or programmed playback results in cancellation of the respective operation.

8 SENSOR

- L :If the tonearm sets down before the beginning of the specified tune, set the switch to this position.
- NORM :During normal operation, the switch should be set to this position.
- H :If the tonearm passes over the specified turn, set the switch to this position.

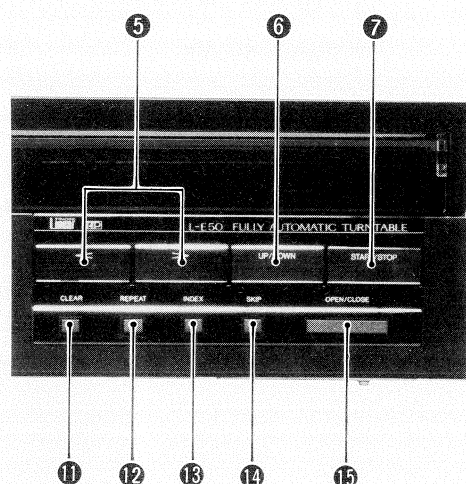

Note: When the position of the SENSOR switch was changed, switch the power off and then back on, or slide the platter out and in again, to cause the tonearm to perform search operation.

9 RANDOM ACCESS PROGRAM

Use these buttons to choose desired tunes for programmed playback. The unit can differentiate between up to 8 tunes for one side of a record, and a maximum of 15 tunes entire can be stored in the memory.

10 REPEAT Indicator

When the REPEAT button is pressed, this indicator lights up in red. While the indicator is lit, the record is played back repeatedly in endless succession.

11 CLEAR

This button is used to clear the playback memory.

12 REPEAT

This button is pressed for repeat playback. When pressed, the REPEAT indicator lights up. As long as the REPEAT indicator is lit, the record will be played back in endless succession. By using the program memory, a selection of up to 15 tunes can be played back repeatedly in the specified order. To terminate repeat playback, press the REPEAT button once more to turn off the REPEAT indicator or press either the START/STOP or OPEN/CLOSE button.

13 INDEX

When this button is pressed, the first 10 seconds of each track are played back, either in the programmed order or, if no tune sequence is stored, in the normal order of the disc.

14 SKIP

This button is used to interrupt playback of a tune and proceed directly to the next.

Note:

- During manual playback the skip function is inactive.
- When a number of tunes is programmed, the skip function will cause playback from the next programmed tune.

15 OPEN/CLOSE

Pressing this button causes the platter to slide out or to retract.

8 SENSOR

- L :If the tonearm sets down before the beginning of the specified tune, set the switch to this position.
- NORM :During normal operation, the switch should be set to this position.
- H :If the tonearm passes over the specified turn, set the switch to this position.

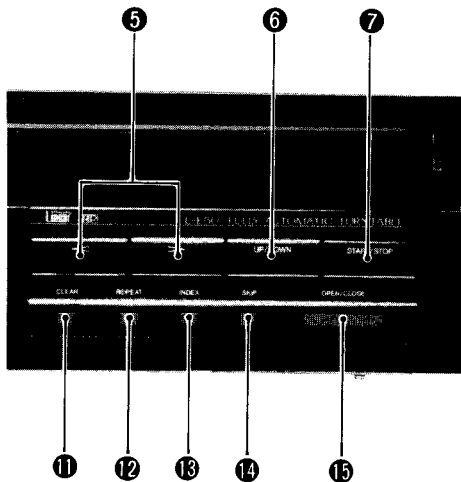

Note: When the position of the SENSOR switch was changed, switch the power off and then back on, or slide the platter out and in again, to cause the tonearm to perform search operation.

9 RANDOM ACCESS PROGRAM

Use these buttons to choose desired tunes for programmed playback. The unit can differentiate between up to 8 tunes for one side of a record, and a maximum of 15 tunes entire can be stored in the memory.

10 REPEAT Indicator

When the REPEAT button is pressed, this indicator lights up in red. While the indicator is lit, the record is played back repeatedly in endless succession.

11 CLEAR

This button is used to clear the playback memory.

12 REPEAT

This button is pressed for repeat playback. When pressed, the REPEAT indicator lights up. As long as the REPEAT indicator is lit, the record will be played back in endless succession. By using the program memory, a selection of up to 15 tunes can be played back repeatedly in the specified order. To terminate repeat playback, press the REPEAT button once more to turn off the REPEAT indicator or press either the START/STOP or OPEN/CLOSE button.

13 INDEX

When this button is pressed, the first 10 seconds of each track are played back, either in the programmed order or, if no tune sequence is stored, in the normal order of the disc.

14 SKIP

This button is used to interrupt playback of a tune and proceed directly to the next.

Note:

- During manual playback the skip function is inactive.
- When a number of tunes is programmed, the skip function will cause playback from the next programmed tune.

15 OPEN/CLOSE

Pressing this button causes the platter to slide out or to retract.

4. Servicing Precautions

1. If the tonearm, motor or any other mechanical parts were detached, disassembled or replaced, always perform check and adjustment of lead-in position.
2. Be sure to perform servicing related to motor revolution only on a level surface.
3. The power cord is connected to the primary leads of the power transformer by means of crimp-on terminals. If this connection has to be removed, re-establish it only with crimp-on connectors and confirm that secure connection has been established.
4. For check procedures of the logic circuit, refer to "Check of Power Supply P.C. Board" on page 1-11.

5. This unit employs the lubricators and bonds specified below. Be sure to use only the designated types.

Brand	Application
Furoil GP-501A Furoil BG-TS-1 (Kanto Kasei Co)	1:1 Ratio Worm and worm gear teeth contact area Bearings on both sides of worm assembly Gustand mesh section Rack gear mesh section Roller section at rear of tonearm
White Grease	V-groove of loading guide
Furoil GP-608	Shaft A, Shaft B

5. Technical Explanation

5-(1) Programmed Music Scan

As opposed to conventional designs, this unit does not use a sensor incorporated into the cartridge, but employs a separate sensor which moves in sync with the tonearm, as shown in the illustration.

1. Detector circuit

This circuit operates in the same way as described in "Optical Detection in UP Position" of the Service Manual for model QL-E55 (No. 2665 Mar. 1983) published previously.

2. Music scanning

When the turntable is activated - except in the manual mode - the tonearm and sensor scan the total record area from the outside to the inside before playback, and the position of the intervals (MARKER SPACE) between musical tracks are stored in the microprocessor (by number of pulses in the rotary encoder). During programmed playback, these data are used to lower the tonearm at the beginning of a designated track and lift it at the end of the track.

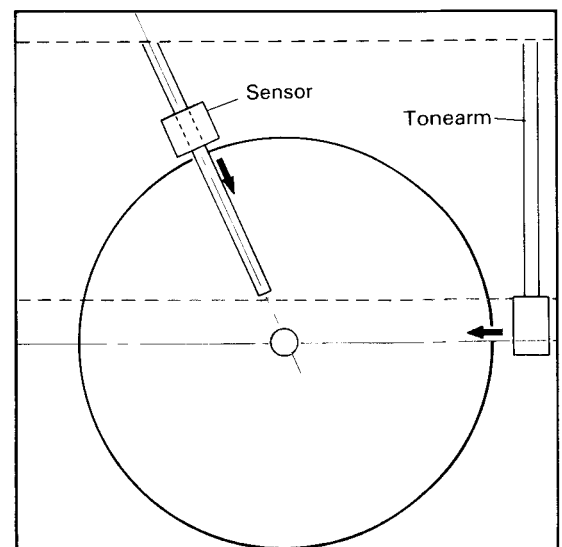

Fig. 1

5-(2) Explanation of Microprocessor Pins (MB88401M/304K)

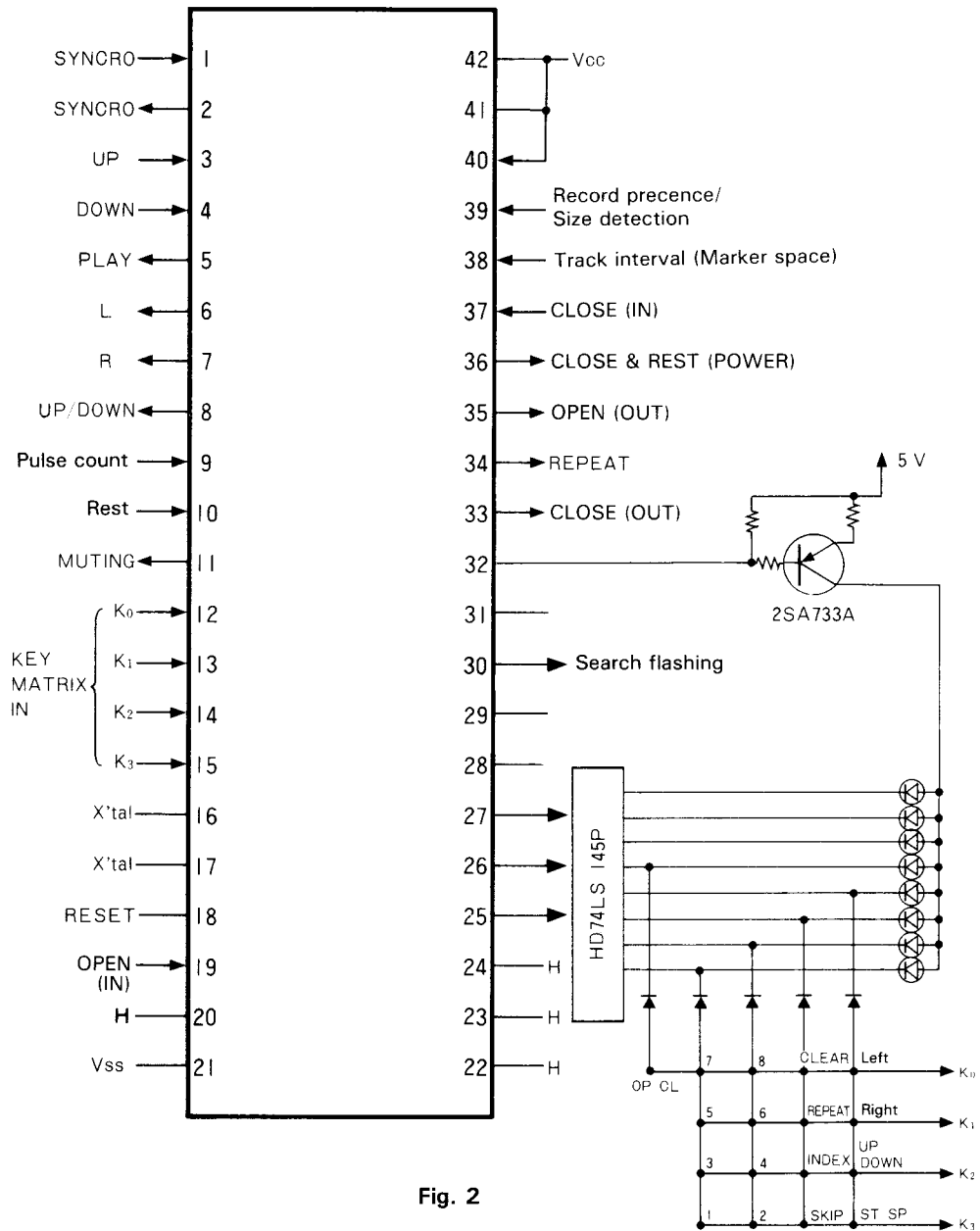

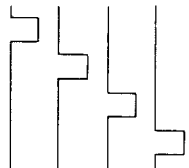



Fig. 2

PIN No.	PORT NAME	INPUT/OUTPUT	COMMENT	
1	R4	I	DCS Input Terminal	
2	R5	O	DCS Output Terminal	
3	R6	I	UP Signal Input Terminal	H ← UP
4	R7	I	DOWN Input Terminal	H ← DOWN
5	R8	O	PLAY Signal Output Terminal	L → PLAY
6	R9	O	L Signal Output Terminal	L → L
7	R10	O	R Signal Output Terminal	L → R
8	R11	O	UP/DOWN Signal Output Terminal	H → DOWN
9	R12	I	PULSE COUNT Input (approx. 10 msec cycle)	 (during arm movement)
10	R13	I	REST Signal Input Terminal	H ← REST
11	R14	O	MUTING Output Terminal	H → MUTING ON
12	K0	I	KEY MATRIX INPUT	 (When any key is pressed.)
13	K1			
14	K2			
15	K3			
16	EX	}	Microprocessor Clock Pulse Terminal	4.19 MHz
17	X			
18	RESET		Reset Terminal	L → During RESET
19	IRQ	I	OPEN Input Terminal	H ← OPEN
20	TC	—		H
21	Vss	Power Supply	OV	L
22	SC/TO	—		H
23	Si	—		H
24	SO	—		H
25	O0	}	BCD Output Terminal	
26	O1			
27	O2			
28	O3	—		
29	O4	—		
30	O5	O	Indicator (flashing)	 (Search)
31	O6	—		
32	O7	O	LED Out	
33	P0	O	CLOSE Output Terminal	L → CLOSE
34	P1	O	REPEAT Output Terminal	L → REPEAT · ON
35	P2	O	OPEN Output Terminal	L → OPEN
36	P3	O	CLOSE & REST Output Terminal	L → CLOSE & REST
37	R0	I	CLOSE Input Terminal	L → CLOSE
38	R1	I	Track Interval Input Terminal	H ← Track Interval
39	R2	I	Record Presence & Size Detection	H → 17 cm (30 cm circumference) H → None (on PLATTER MAT)
40	R3	I	PULSE COUNT switching	L → 0 H → -3
41	VM	} Power Supply	5V	
42	Vcc			

6. Stylus Replacement

6-(1) Removal

Pull out the stylus assembly steadily in direction of the arrow, as shown in the illustration. Do not pull the assembly forward or at an angle to the cut-out.

Note: Stylus replacement is facilitated by removing the cartridge first.

6-(2) Attachment

Fit the protruding section of the stylus assembly into the cut-out on the cartridge and slide the assembly smoothly in, as shown in the illustration. Do not slide at an angle to the cut-out.

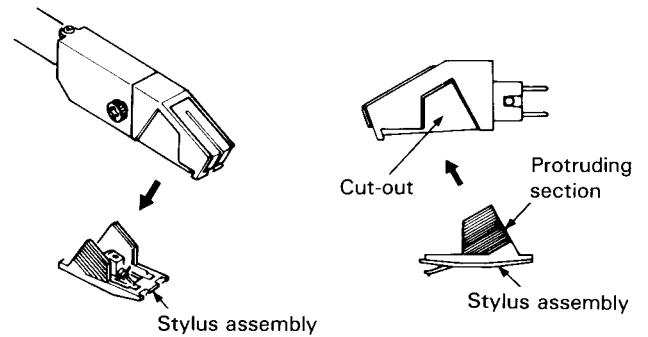

Fig. 3

7. Cartridge Replacement

This unit is designed for use with T4P plug-in type cartridges. Cartridge replacement with another cartridge of this type is possible. For replacement, loosen the fastening screw of the cartridge and pull the cartridge out, as shown in the illustration.

Note: Be sure to use the cartridge fastening screw of this unit even with another cartridge, in order to ensure correct tracking force.

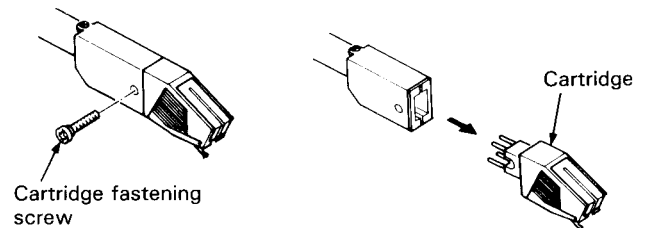

Fig. 4

8. Removal Procedures

8-(1) Disassembly Procedure

1. Removal of metal cover

Remove the screws on both sides of the unit (4 pcs) and on the rear panel of the unit (5 pcs), and pull the cover straight up while slightly spreading it.

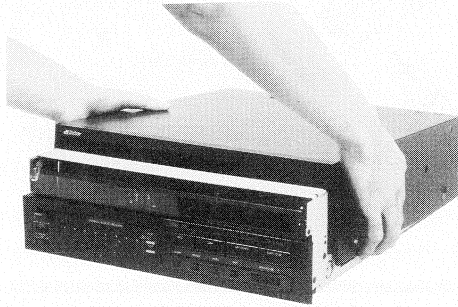
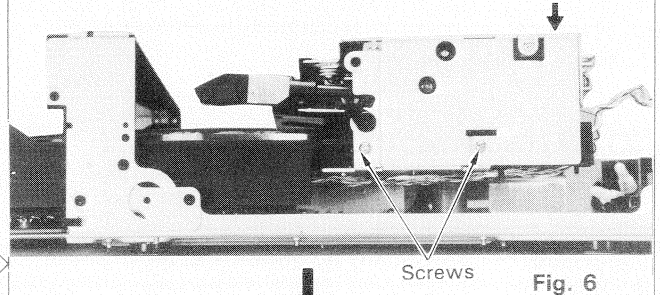

Fig. 5

2. Removal of mechanism base assembly

Remove the screws shown in the illustration (4 on the sides of the unit and 1 on top) and unhook the wire in the rear from its clamp to loosen it. Then pull the base straight up.



Screws

Fig. 6

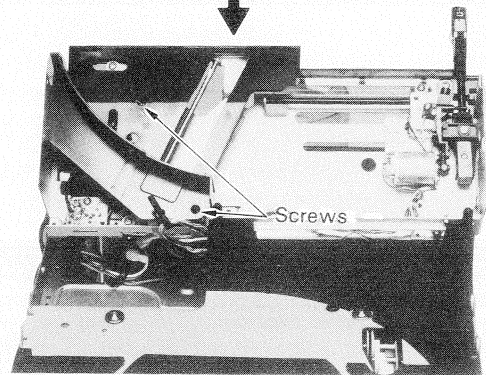

Screws

Fig. 7

3. Removal of platter base

Take off the platter and loosen the screws (5 pcs) shown in the illustration. Lift the cabinet up.

Note: Be careful not to disturb the cartridge stylus or the sockets and wires on the PCB.

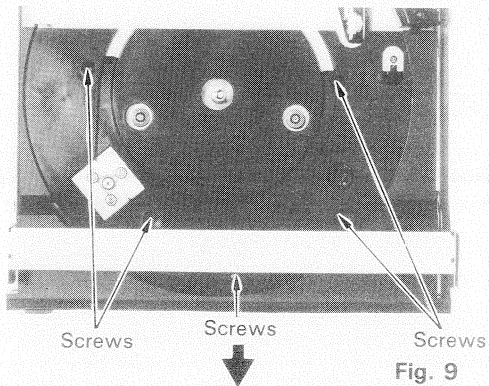

Screws

Screws

Screws

Fig. 9

Remove the ground wire and the 4 screws shown in Fig. 10, and remove the platter base.

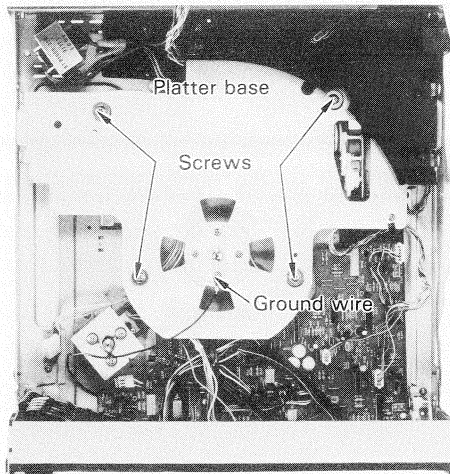

Platter base

Screws

Ground wire

Fig. 10

4. Removal of loading drive motor

Remove the belt and remove the motor assembly.

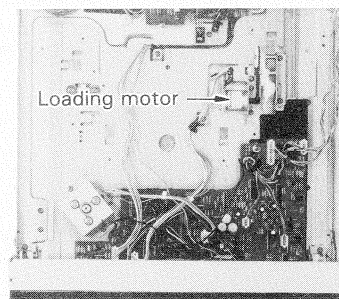

Loading motor

Fig. 11

8-(2) Removal and Attachment of Platter Compartment Door

1. Remove screws ① and ② shown in the illustration, and pull out the cam to remove the door.

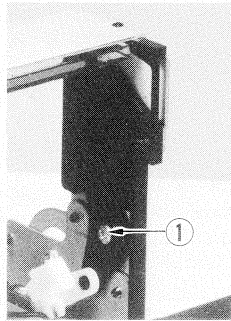

Fig. 12

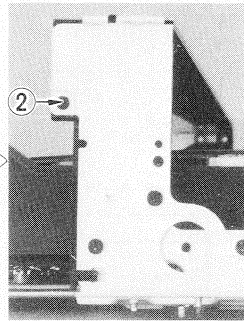

Fig. 13

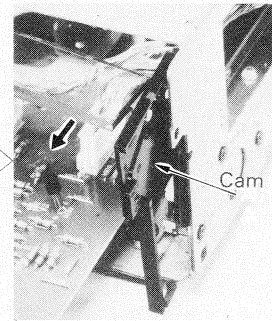

Fig. 14

2. To attach the door, reverse the procedure. Push the door lever by hand and insert the projection ① into the slot.

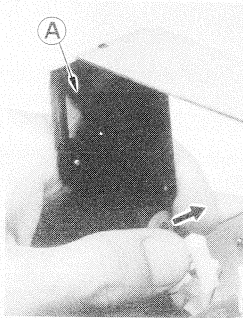

Fig. 15

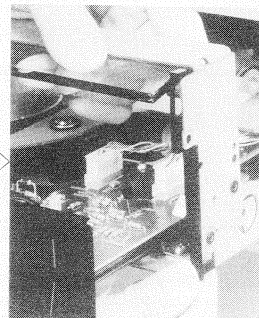

Fig. 16

9. Rope Suspension

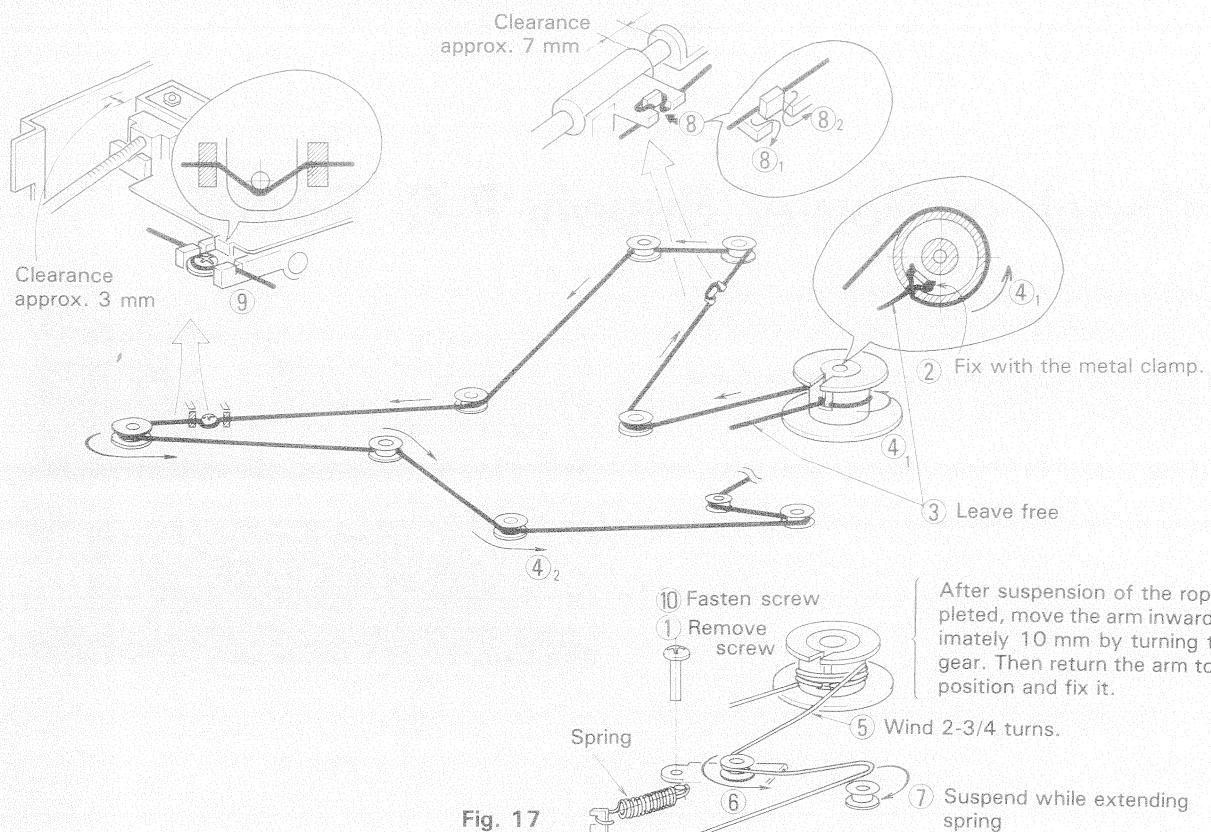

Fig. 17

10. Block Diagram

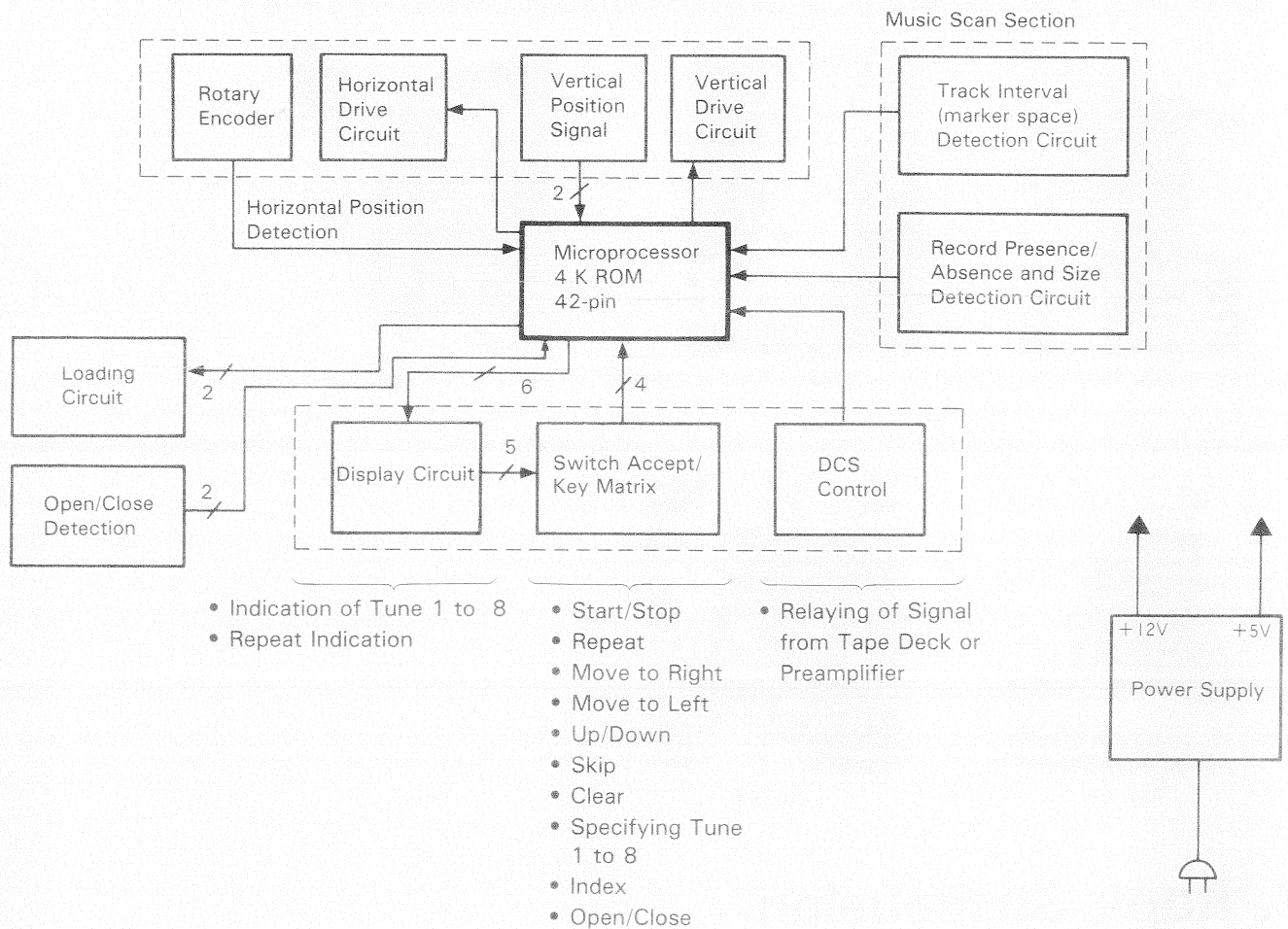

Fig. 18

11. Check of Power Supply P.C. Board

To check the power supply circuit and logic circuit in the playback mode, the loading mechanism must be in the open condition.

- To open the loading mechanism, short-between pin 3 and pin 4 of P2.

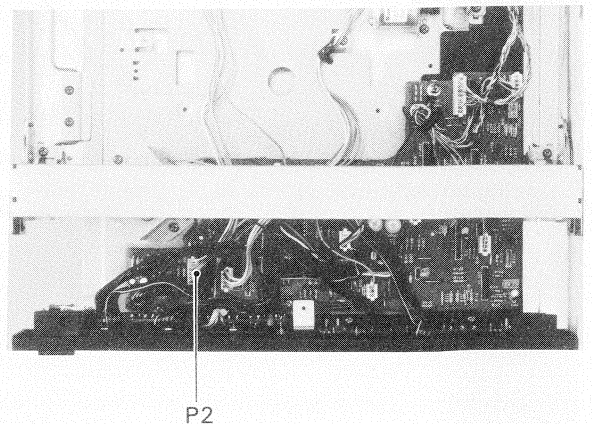

Fig. 19

12. Adjustment Procedures

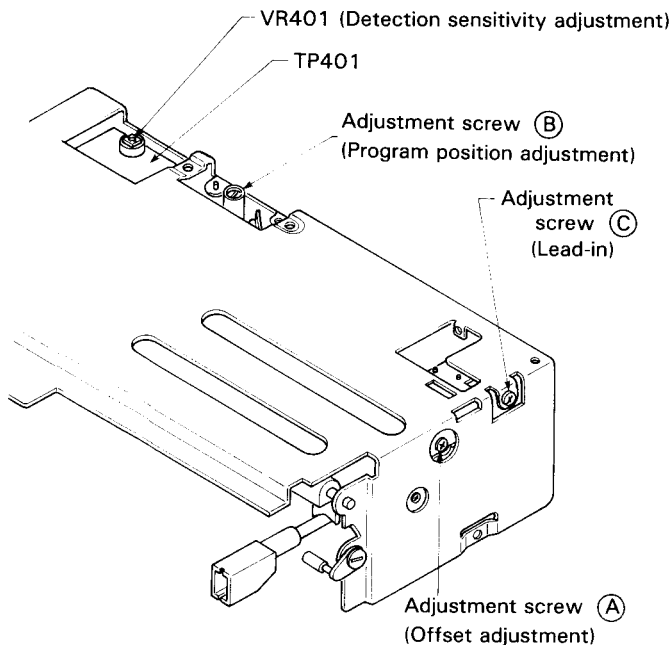

Fig. 20

12-(1) Offset Adjustment

1. Set the tonearm to the UP position.
2. Short-between test points TP204 and TP206. If the arm moves towards the lead-in position at this time, turn adjustment screw (A) until it remains stationary.
3. Adjust screw (A) to obtain a voltage of 0.8 ± 0.2 V between TP201 and TP202.

12-(2) Track Interval (Marker Space) Detection Sensor Sensitivity Adjustment

1. Move the sensor to a position above the reflective ring on the inner circumference of the platter mat. (Use the < button to move the arm inwards.)
2. Adjust VR401 to obtain a potential of $2.1 \text{ V} \pm 0.3 \text{ V}$ between TP401 and TP402 (or TP403).

Note: As the sensor sensitivity is strongly influenced by external light, reduce ambient lighting as much as possible when performing this adjustment.

12-(3) Lead-In Adjustment

Adjust the adjustment screw (C) for a lead-in count of 23 ± 2 for 30-cm records. Check also the lead-in and the lead-out position for 17-cm records.

	Test Record	Count	
30-cm Lead-In	RG325	23 ± 2	Adjustment
17-cm Lead-In	SS-4445	23 ± 5	Check
17-cm Lead-Out	SS-4445	26 ± 4	Check

12-(4) Motor Speed Adjustment

1. With the platter in the extended position, turn the worm pulley by hand to move the arm towards the lead-in position. The platter starts rotating.
2. Adjustment of 33/45 Speed.
Set the SPEED selector to "33" (or "45") and adjust VR501 (or VR502) while checking speed with a stroboscope sheet.

Note: Always perform the adjustment of 33 speed first.
The adjustment semifixed resistors are located in the loading base and marked "A" for 33-1/3 rpm and "B" for 45 rpm.

12-(5) Program Position (Touch-Down Position) Adjustment

Turn the adjustment screw (B) to the left (↶) or right (↷).

- Note:**
- Correct position adjustment will be possible within about one revolution of the screw. Do not turn the screw excessively.
 - After adjusting screw (B), slide the platter out and in again, cause the tonearm to perform search, and then check the touch-down position. If the search operation is not performed, the touch-down position will not change even if the adjustment screw was turned.

13. Connection Diagram

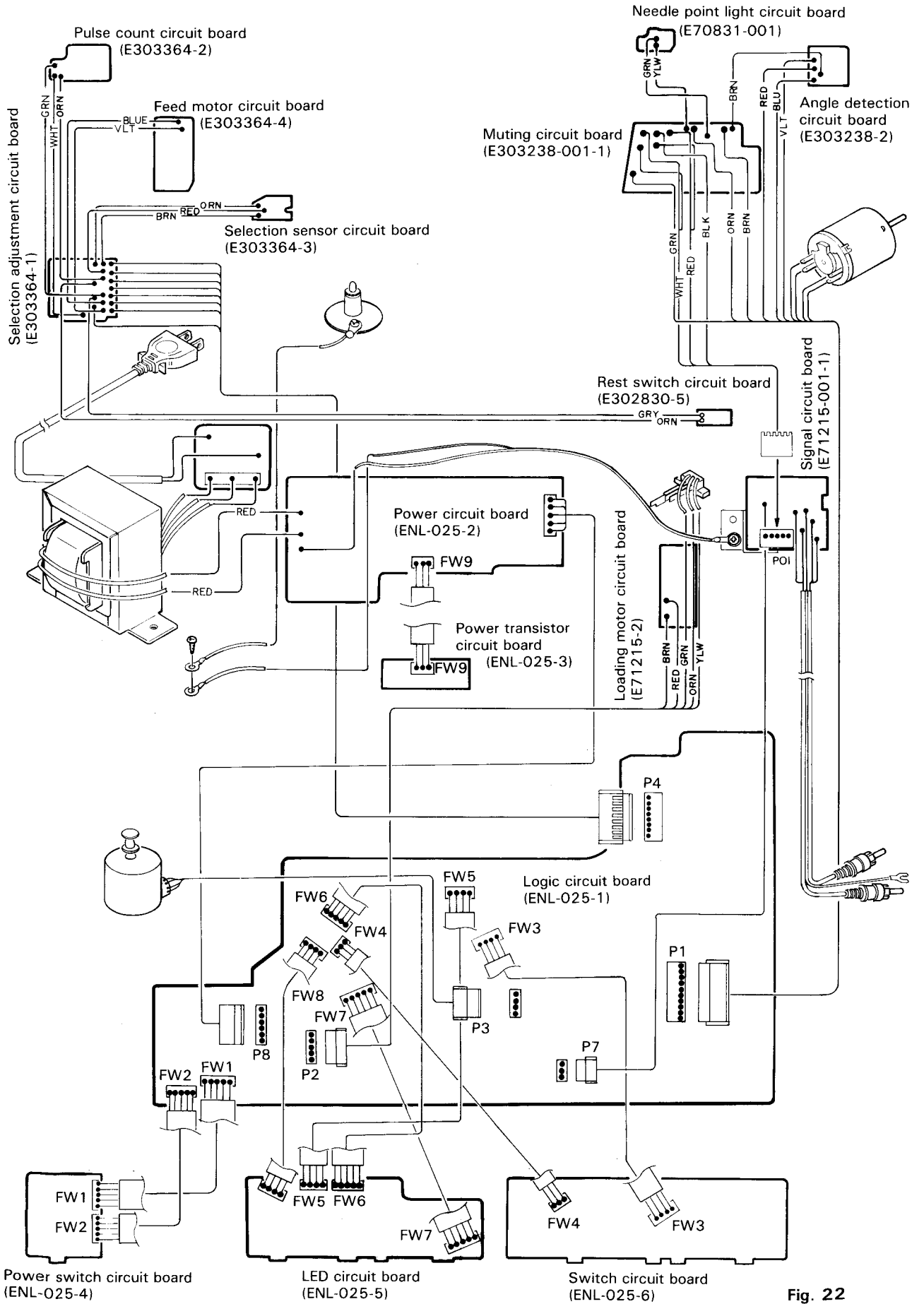

Fig. 22

14. Power Cord Connections in Different Areas

■ for U.K., Australia & Europe

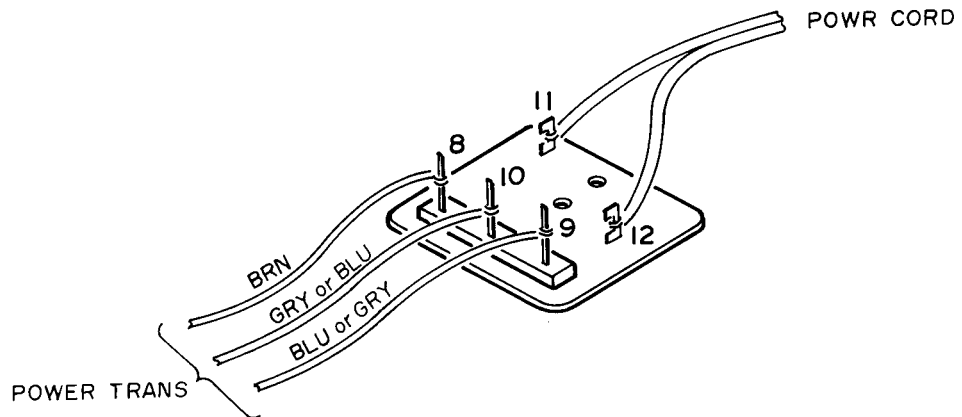

Fig. 22

	U.K., A	E
8	BRN	BRN
9	GRY	BLU
10	BLU	GRY

■ for U.S. Military Market & Other Countries

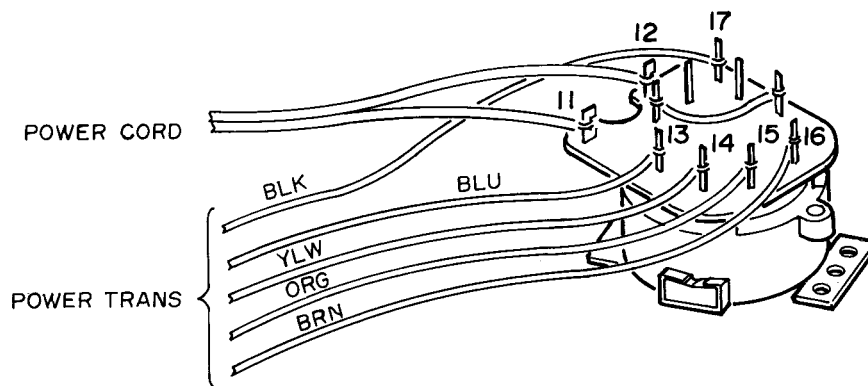
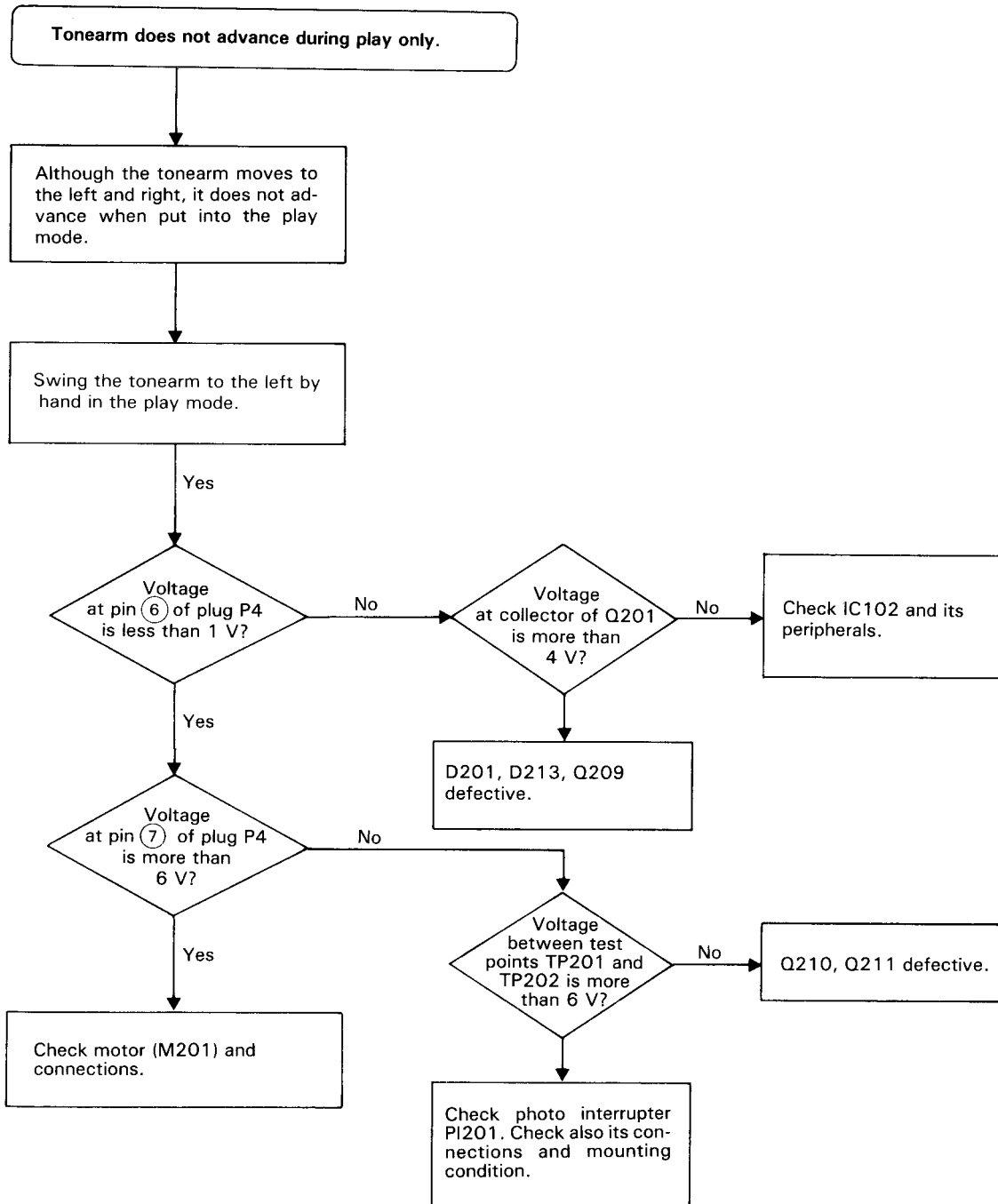
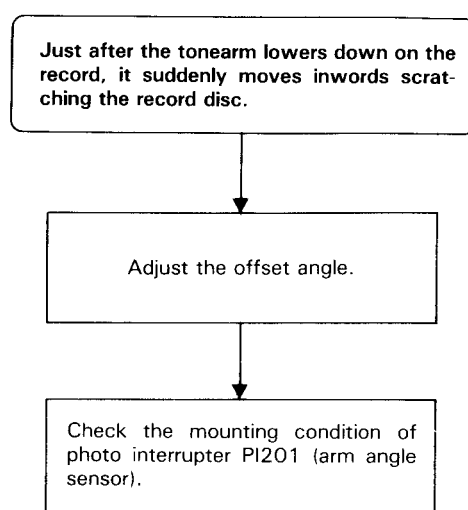
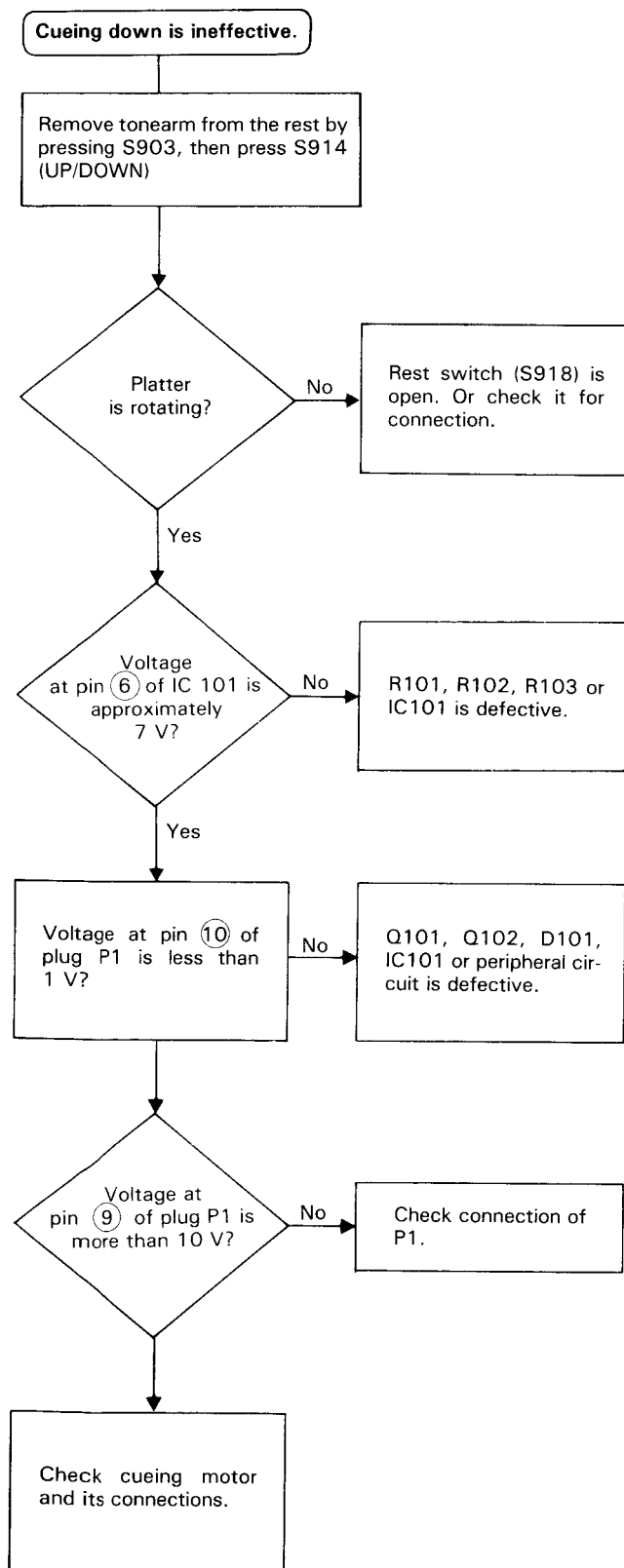
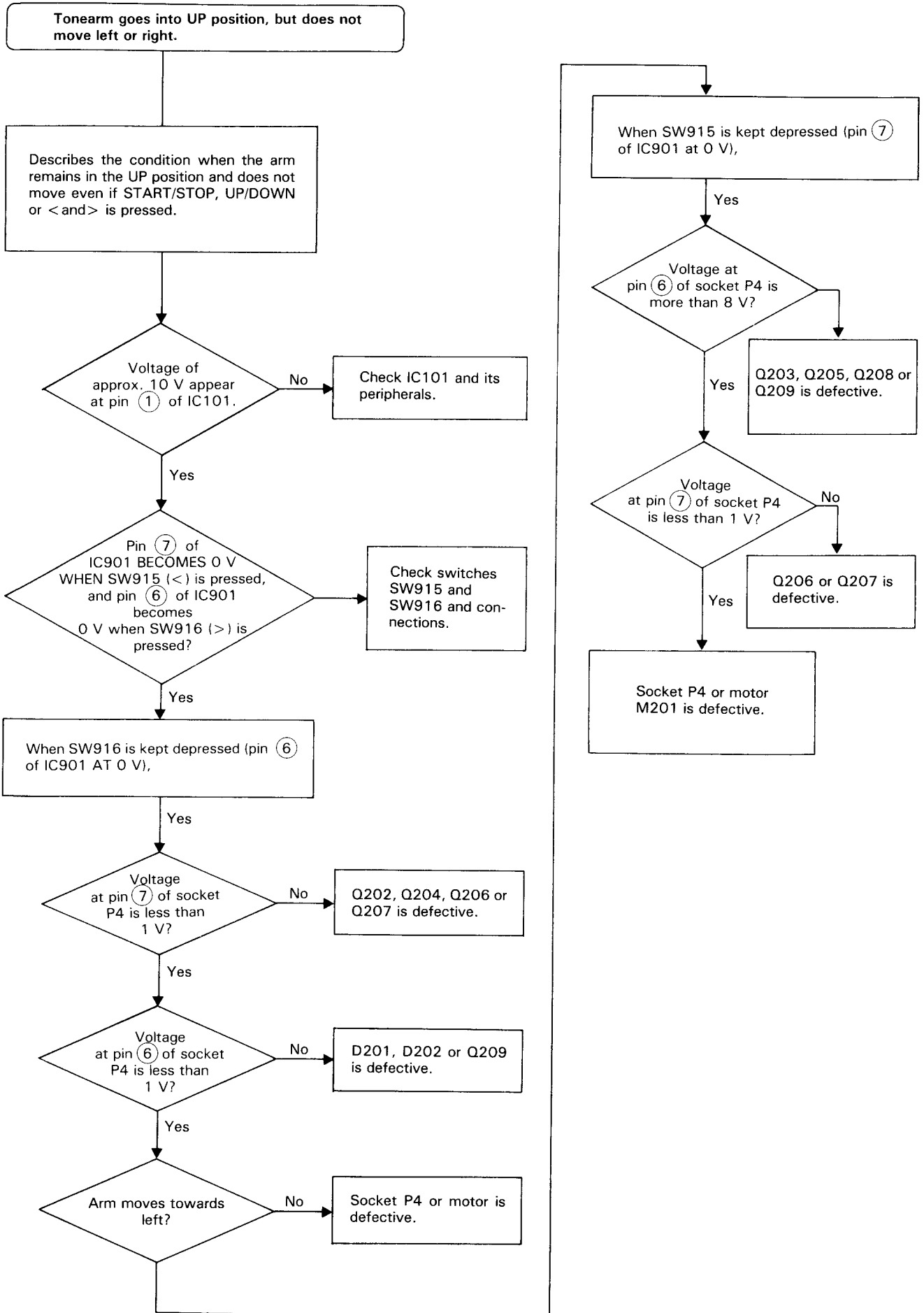

Fig. 23

15. Troubleshooting







16. L-E50B Schematic Diagram

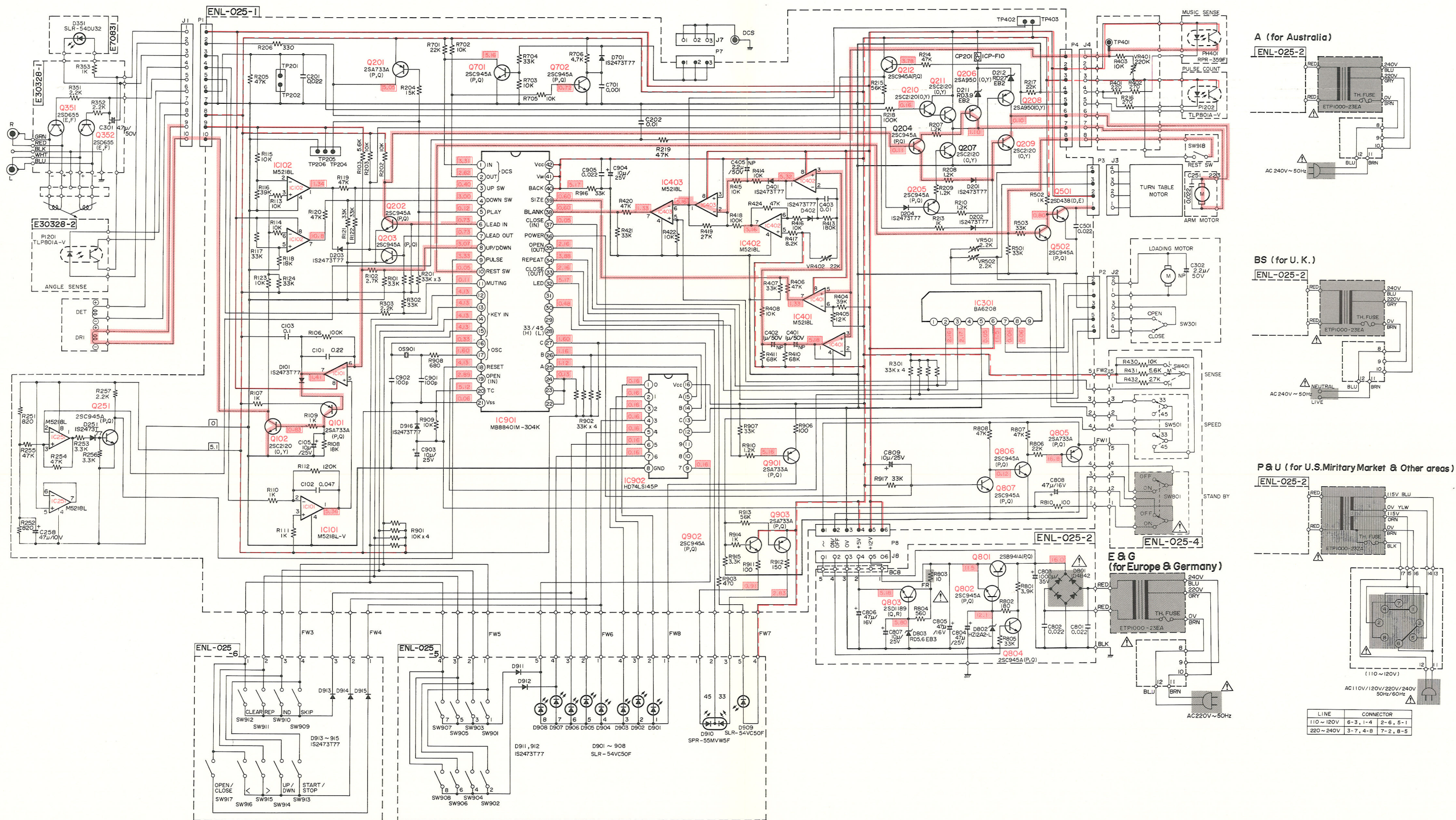

LINE	CONNECTOR
110 ~ 120V	6-3, 1-4
220 ~ 240V	3-7, 4-B
	2-6, 5-1
	7-2, 8-5

PARTS LIST

Contents

Main Parts Location	2-2
Exploded View and Parts Numbers	2-3
Exploded View of Mechanism and Parts Numbers.....	2-7
Printed Circuit Board Ass'y and Parts List	2-9
• ENL-025□ Main P.C. Board Ass'y	2-9
• Muting P.C. Board Ass'y	2-12
• Sensor P.C. Board Ass'y	2-12
• Signal P.C. Board Ass'y	2-12
Packing Materials and Part Numbers	2-13
Accessories List	2-15

Main Parts Location

Front View

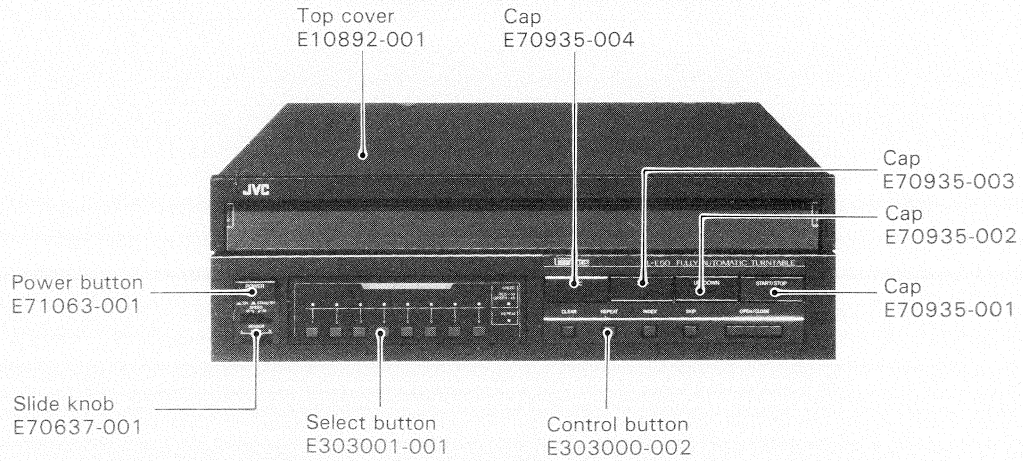
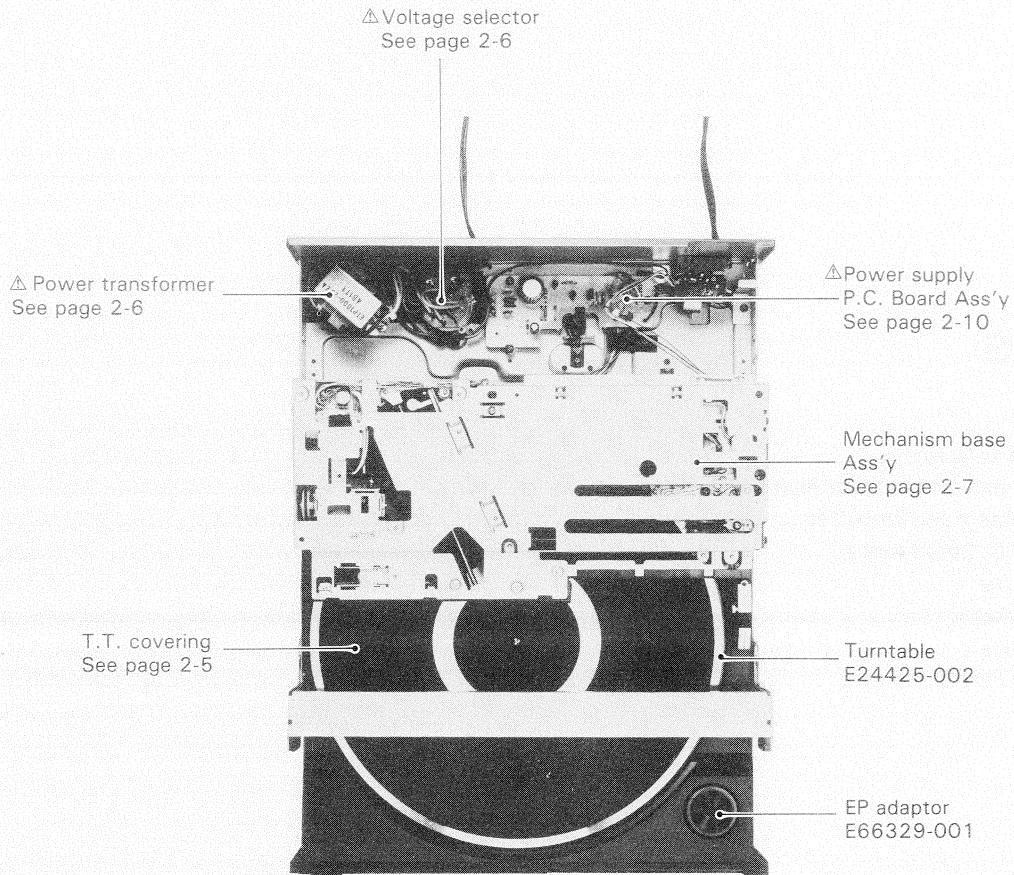

Fig. 1

Top View



△ : Safety Parts

The Marks for Designated Areas.

E	Europe	P,PG	U.S.Military Market
G	West Germany	BS	U.K.
ES	Spain	U	Other Countries
A	Australia		

No mark indicates all areas.

No.	Part Number	Part Name	Q'ty	Description	Area
1	E10892-001	Top Cover	1		
2	E71090-001	Cap	2	Sensor	
3	SBSB3006M	Tapping Screw	9		
4	E61660-004	Special Screw	4	Side	
5	E24487-002	Door Cover	1		
6	E70912-001	JVC Mark	1		
7	E302859-002	T.T. Covering Ass'y	1		
8	E24425-002	Turn Table	1		
9	E10897-003	Cabinet	1		
10	SBST3018Z	Tapping Screw	4		
11	E69879-001	Belt	1		
12	E70624-001	F. Rubber	4		
14	E70593-001	Special Screw	4		
15	E50670-005	Wire Clamp	1		
16	SBST3006Z	Tapping Screw	57		
17	E24483-005	T.T. Base	1		
18	E70595-001	Motor Bracket	1		
19	E67824-004	Pulley	1		
20	SPSP2003Z	Screw	2		
21	E24482-003	Rear Panel	1		
22	E70844-001	Shaft	1		
23	E71087-001	Loading Roller	1		
24	E70845-001	Special Screw	2		
25	E70585-001	C. Board Holder	5	Short	
26	E10894-003	Loading Base	1		
27	E69782-001	Belt	1		
28	E71092-002	Cover (R)	1		
29	E71084-001	Ball Holder	1		
30	G41505-5	Steel Ball	4		
31	E302840-003	Gear Ass'y	1		
32	E302841-002	Gear Base Ass'y	1		
33	E302848-001	Pulley	1		
34	E302846-001	Gear (A)	1		
35	E302847-001	Gear (B)	1		
36	E70611-001	Gear (C)	1		
37	REE3000X	E. Ring	2		
38	E24621-002SA	Front Panel Ass'y	1		
39	E10923-001	Front Panel	1		
40	E70934-001	Stay Bracket	1		
41	E303000-002	Control Button	1		
42	E303001-001	Select Button	1		
43	E70937-002	Ornament (B)	1		
44	E70938-003	Ornament (C)	1		
45	E70939-002	Ornament (D)	1		
46	E70933-001	Window Screen	1		
47	E70930-002	Ornament (A)	1		
48	E70935-001	Cap	1		
49	E70935-002	Cap	1		
50	E70935-003	Cap	1		
51	E70935-004	Cap	1		
52	SBSF3008Z	Screw	6		
53	E70589-001	Roller	1		
54	E70590-002	Shaft	1		
55	SBSB3008M	Tapping Screw	1		
56	E10893-002	Bottom Board	1		
57	E47227-021	Foot	4	Long	
58	E70585-002	C. Board Holder	3		
59	SBST3012Z	Tapping Screw	7		Except BS
△60	QHS3876-162	Cord Stopper	2		BS
	QHS3876-162BS	Cord Stopper	2		

△: Safety Parts

No.	Part Number	Part Name	Q'ty	Description	Area
61	E71083-002	Ball Holder	1		
62	E302844-001	Rack	1		
63	E47227-022	Foot	2		
64	E302941-002	Cam	1	R	
65	SSSB2606M	Screw	2		
66	REE2000X	E. Ring	1		
67	E303182-001	Lever Base Ass'y	1	L	
68	E71085-001	L. Base Sub Ass'y	1		
69	E302858-001	Lever (A)	1		
70	E70592-001	Lever (B)	1		
71	E70629-001	Spring (A)	1		
72	E70630-001	Spring (B)	1		
73	E303182-002	Lever Base Ass'y	1	R	
74	E70592-002	Lever (B)	1		
75	E70629-002	Spring (A)	1		
76	E302858-002	Lever (A)	1		
77	E70630-001	Spring (B)	1		
78	E71085-001	L. Base Sub Ass'y	1		
79	REE3000X	E. Ring	2		
80	E71162-001	Wire Plate	1		
81	E24484-002	Door Ass'y	1		
82	E302857-002	Door Lever	1	R	
83	E302857-001	Door Lever	1	L	
84	E70628-001	Special Screw	2		
85	E302941-001	Cam	1	L	
86	E24486-002	Door	1		
87	E71220-001	Stopper	1		
88	E71218-001	Roller Shaft	1		
89	E71294-001	Spring	1		
90	E302843-001	Ball Holder	1		
91	E70637-001	Slide Knob	2		
92	E71063-001	Power Button	1		
93	E10896-001	Door Base	1		
94	SSST3006M	Tapping Screw	6		
95	E71161-001	Sheet	1		
96	E60134-001	Special Screw	2		
97	E71217-001	Roller Bracket	1		
98	E70328-002	Stylus Cover	1		
99	E66052-001	Special Screw	1		
△100	QMP7600-250	Power Cord	1		U,P,PG
	QMP3900-200	Power Cord	1		E,G,ES
	QMP2560-244	Power Cord	1		A
	QMP9017-008BS	Power Cord	1		BS
101	EWP306-001	Signal Cord	1		
102	EX0010010N70	Spacer	2		
103	MD-1045	Cartridge	1		
104	E71535-001	Trans. Bracket	1		
105	E70845-002	Screw	1		
106	E300763-005	Motor	1		
△107	ETP1000-23ZA	Power Transformer	1		U,P,PG
	ETP1000-23EA	Power Transformer	1		E,A,G,ES
△108	ETP1000-23EABS	Power Transformer	1		BS
	QSR0085-007	Voltage Selector	1		U,P,PG
△109	E303428-001	Primary Case	1		E,A,G,BS,ES
△110	E303429-001	Primary Cover	1		E,A,G,BS,ES
111	SBSF3008Z	Tapping Screw	1		E,A,G,BS,ES
112	E10907-001	Base Joint	1		
113	E69632-003	Spindle Ass'y	1		
114	E70940-001	Motor Base	1		
115	E68682-002	Rubber Bushing	3		
116	E68683-001	Screw	3		
117	VFO2R13	Motor	1		

Exploded View and Part Numbers

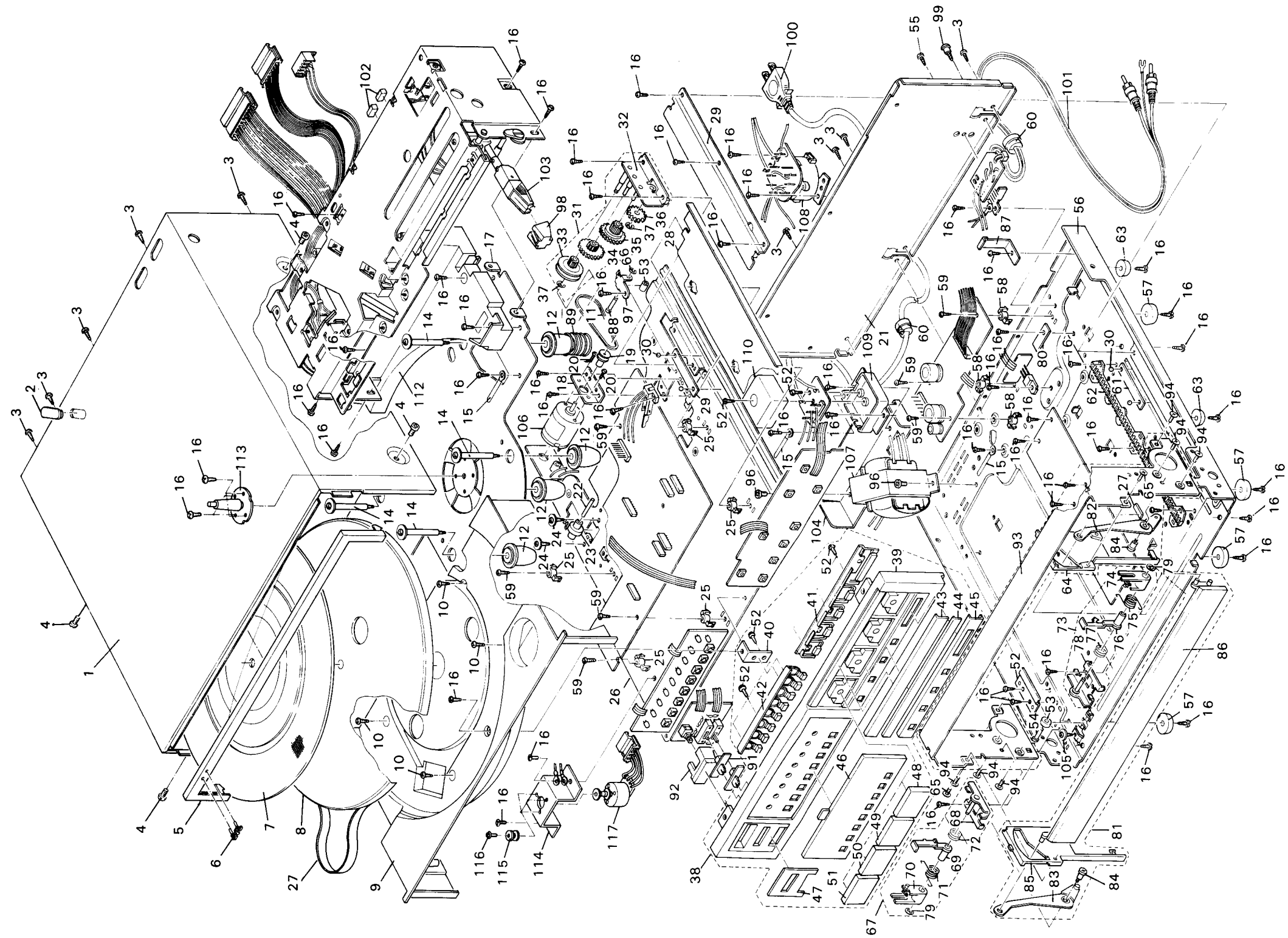

Fig. 3

Exploded View of Mechanism

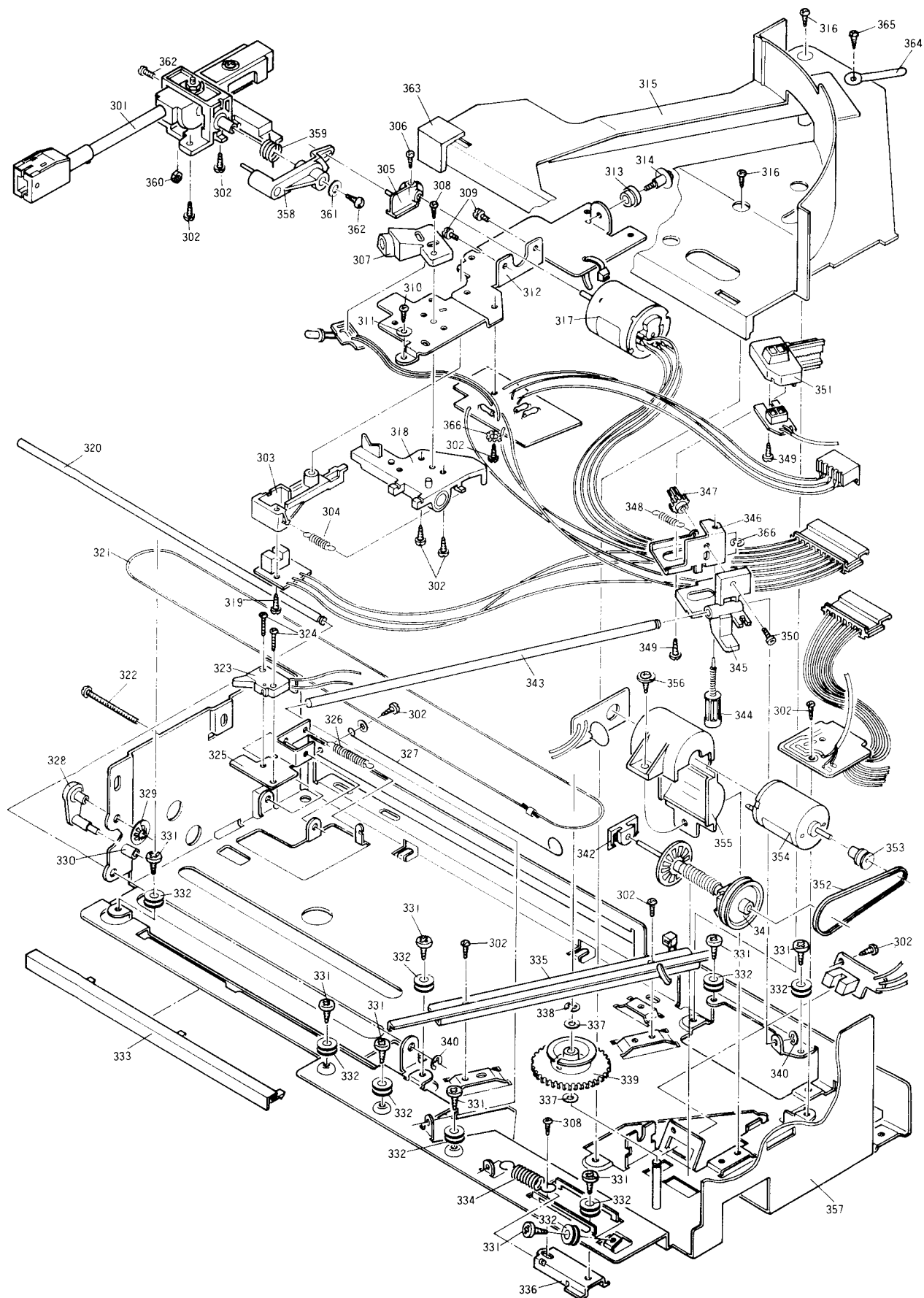

Fig. 4

Mechanism Ass'y List

Item	Part Number	Part Name	Q'ty	Description
301	E24524-001	Tonearm Ass'y	1	
302	SBST3006Z	Screw	5	
303	E302897-001	Lever	1	
304	E70604-001	Spring	1	
305	E70601-001	Cueing Lever (A)	1	
306	SPSP3006Z	Screw	1	
307	E70625-001	LED Holder	1	
308	SBST3008Z	Screw	1	
309	LPSP3005Z	"	2	
310	DBST3006Z	"	1	
312	E302849-002	Arm Base	1	
313	E70602-001	Roller	1	
314	E69851-001	Screw	1	
315	E24481-002	M. Cover (A)	1	
316	SBST3018Z	Screw	2	
317	E302538-002	Motor	1	
318	E70603-002	Hook Ass'y	1	
319	SBSF3006Z	Screw	1	
320	E70607-001	Arm Shaft	1	
321	E70623-002	Rope Ass'y	1	
322	SPSP3035M	Screw	1	
323	QSS1201-034	Slide Switch	1	
324	SPSP2008Z	Screw	2	
325	E70608-001	Switch Bracket	1	
326	E70609-001	Spring	1	
327	E71089-001	"	1	
328	E70605-001	Lever	1	
329	E70007-001	Speed Nut	1	
330	E70267-002	Rubber Tube	4	
331	E70620-001	Screw	8	
332	E70619-001	Roller	9	
333	E70633-001	M. Cover (B)	1	
334	E70622-001	Spring	1	
335	E70616-001	Bracket	1	
336	E70621-002	Roller Bracket	1	
337	Q03093-817	Spacer	2	
338	REE3000X	E Ring	1	
339	E302855-001	Warm Wheel	1	
340	REE2500X	E Ring	2	
341	E302856-001	Warm Ass'y	1	
342	E69875-001	Bearing Stand	1	
343	E70610-001	Shaft (B)	1	
344	E70613-001	Warm	1	
345	E302852-001	Holder	1	
346	E302853-001	Bracket	1	
347	E70614-001	Gear (S)	1	
348	E70612-001	Spring	1	
349	SBSB2605Z	Screw	2	
350	LPSP2606Z	"	1	
351	E302851-001	Case	1	
352	E69879-001	Belt	1	
353	E67824-004	Pully	1	
354	E300763-005	Motor	1	
355	E302854-001	Motor Holder	1	
356	E69851-004	Screw	1	
357	E10895-001	Mechanism Base Sub Ass'y	1	
358	E302863-001	Cueing Lever (B)	1	
359	E70645-001	Spring	1	
360	NTB2600	Nut	1	
361	E67605-001	Washer	1	
362	SPSP2608Z	Screw	1	
363	EX0025012N10S	Spacer	1	
364	E50670-005	Wire Clamp	1	
365	SBSF3006Z	Screw	1	
366	E71331-001	E Ring	1	

Printed Circuit Board Ass'y and Parts List

ENL-025 □ Main P.C. Board Ass'y

Note: ENL-025 □ varies according to the areas employed. See note (1) when replacing an order.

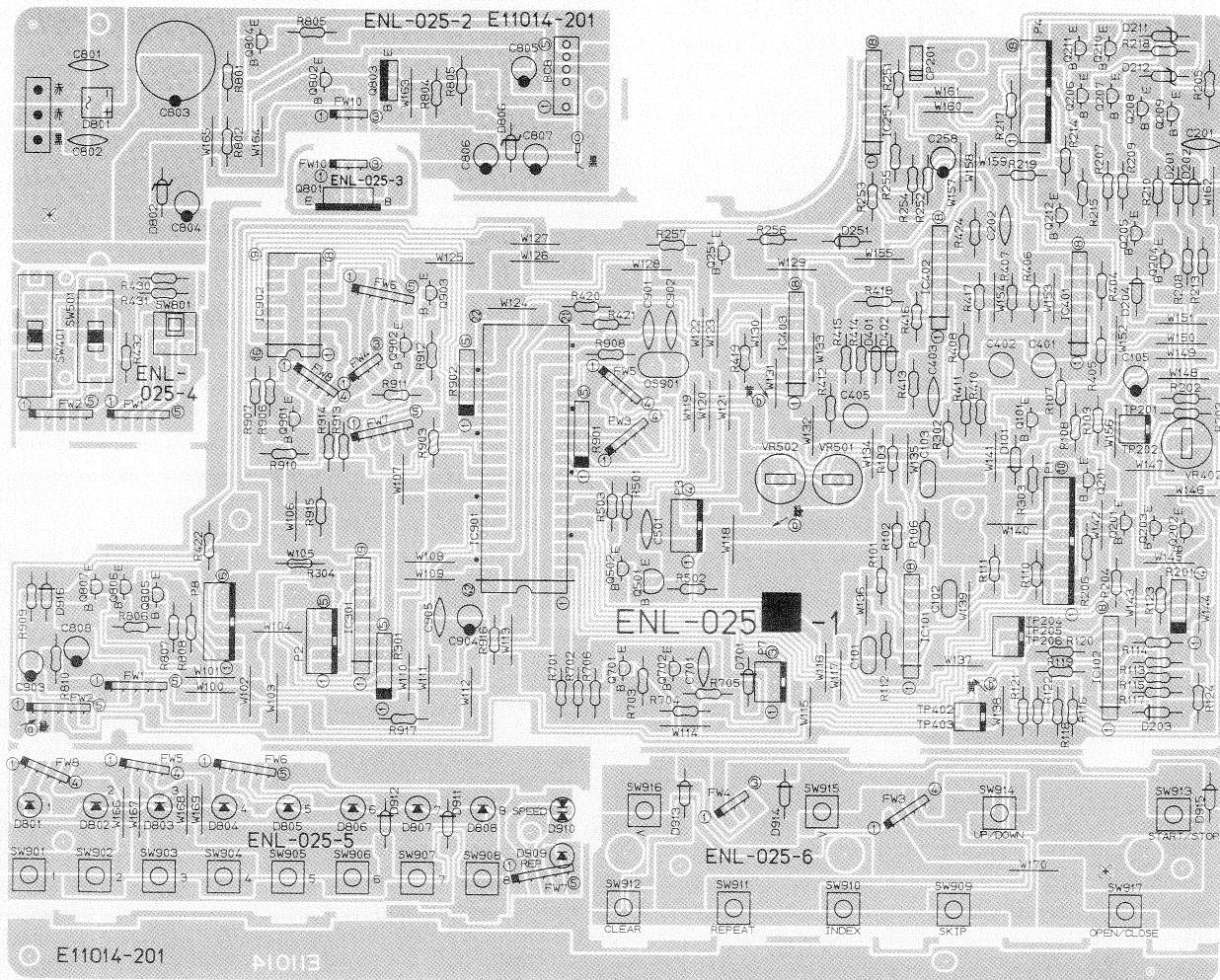

Fig. 5

Note (1)

Designated Areas	P.C. Board Ass'y
U.S.A., Canada	ENL-025 B
Europe, Australia, U.S. Military Market Other Countries	ENL-025 C
U.K.	ENL-025 D

Note (2)

The symbols (赤 , 黒 , 白etc.) on P.C. Board surface are factory process only.

Each Individual P.C. Board Location

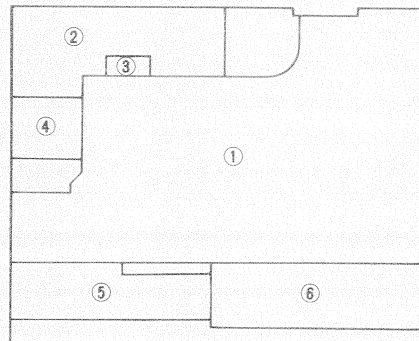

Fig. 6

- ① ENL-025-1 Logic P.C. Board Ass'y
- ② ENL-025-2 Power Supply P.C. Board Ass'y
- ③ ENL-025-3 Power Transistor P.C. Board Ass'y
- ④ ENL-025-4 Power Switch P.C. Board Ass'y
- ⑤ ENL-025-5 LED P.C. Board Ass'y
- ⑥ ENL-025-6 Switch P.C. Board Ass'y

Transistors

Item No.	Parts Number	Description	
			Maker
Q101	2SA733A(P,Q)	Silicon	NEC
Q102	2SC2120(O,Y)	Silicon	Toshiba
Q201	2SA733A(P,Q)	Silicon	NEC
Q202	2SC945A(P,Q)	Silicon	NEC
Q203	2SC945A(P,Q)	Silicon	NEC
Q204	2SC945A(P,Q)	Silicon	NEC
Q205	2SC945A(P,Q)	Silicon	NEC
Q206	2SA950(O,Y)	Silicon	Toshiba
Q207	2SC2120(O,Y)	Silicon	Toshiba
Q208	2SA950(O,Y)	Silicon	Toshiba
Q209	2SC2120(O,Y)	Silicon	Toshiba
Q210	2SC2120(O,Y)	Silicon	Toshiba
Q211	2SC2120(O,Y)	Silicon	Toshiba
Q212	2SC945A(P,Q)	Silicon	NEC
Q251	2SC945A(P,Q)	Silicon	NEC
Q501	2SD438(D,E)	Silicon	Sanyo
Q502	2SC945A(P,Q)	Silicon	NEC
Q701	2SC945A(P,Q)	Silicon	NEC
Q702	2SC945A(P,Q)	Silicon	NEC
Q801	2SB941A(P,Q)	Silicon	Matsushita
Q802	2SC945A(P,Q)	Silicon	NEC
Q803	2SD1189(Q,R)	Silicon	Rohm
Q804	2SC945A(P,Q)	Silicon	NEC
Q805	2SA733A(P,Q)	Silicon	NEC
Q806	2SC945A(P,Q)	Silicon	NEC
Q807	2SC945A(P,Q)	Silicon	NEC
Q901	2SA733A(P,Q)	Silicon	NEC
Q902	2SC945A(P,Q)	Silicon	NEC
Q903	2SA733A(P,Q)	Silicon	NEC

ICs

Item No.	Parts Number	Description	
			Maker
IC101	M5218L-V	I.C.	Mitsubishi
IC102	M5218L-V	I.C.	Mitsubishi
IC251	M5218L	I.C.	Mitsubishi
IC301	BA6208	I.C.	Rohm
IC401	M5218L	I.C.	Mitsubishi
IC402	M5218L	I.C.	Mitsubishi
IC403	M5218L	I.C.	Mitsubishi
IC901	MB88401M-304K	I.C.	Fujitsu
IC902	HD74LS145P	I.C.	Hitachi

Diodes

Item No.	Parts Number	Description	
			Maker
D101	1S2473	Silicon	Rohm
D201	1S2473	Silicon	Rohm
D202	1S2473	Silicon	Rohm
D203	1S2473	Silicon	Rohm
D204	1S2473	Silicon	Rohm
D211	RD3.3EB2	Zener	NEC
D212	RD2.7EB2	Zener	NEC
D251	1S2473	Silicon	Rohm
D401	1S2473	Silicon	Rohm
D402	1S2473	Silicon	Rohm
D701	1S2473	Silicon	Rohm
D801	1D4B42	Silicon	Toshiba
D802	HZ12A2-L	Silicon	Hitachi
D803	RD5.6EB3	Zener	NEC
D901	SLR-54VC50F	L.E.D.	Rohm
D902	SLR-54VC50F	L.E.D.	Rohm
D903	SLR-54VC50F	L.E.D.	Rohm
D904	SLR-54VC50F	L.E.D.	Rohm
D905	SLR-54VC50F	L.E.D.	Rohm
D906	SLR-54VC50F	L.E.D.	Rohm
D907	SLR-54VC50F	L.E.D.	Rohm
D908	SLR-54VC50F	L.E.D.	Rohm
D909	SLR-54VC50F	L.E.D.	Rohm
D910	SPR-55MVW5F	L.E.D.	Rohm
D911	1S2473	Silicon	Rohm
D912	1S2473	Silicon	Rohm
D913	1S2473	Silicon	Rohm
D914	1S2473	Silicon	Rohm
D915	1S2473	Silicon	Rohm
D916	1S2473	Silicon	Rohm

Capacitor

Item No.	Parts Number	Description		
C101	QFN31HK-224	0.22 MF	50 V	Mylar
C102	QFN31HK-473	0.047 MF	50 V	Mylar
C103	QFN31HK-104	0.1 MF	50 V	Mylar
C105	QET61EM-106	10 MF	25 V	Electro
C201	QCF31HP-223	0.022 MF	50 V	Ceramic
C202	QCF31HP-103	0.01 MF	50 V	Ceramic
C258	QET61AM-476	47 MF	10 V	Electro
C302	QET61AM-476	47 MF	10 V	Electro
C401	QEN61HM-105	1 MF	50 V	Non Pole
C402	QEN61HM-105	1 MF	50 V	Non Pole
C403	QCF31HP-103	0.01 MF	50 V	Ceramic
C405	QEN61HM-225	2.2 MF	50 V	Non Pole
C501	QCF31HP-223	0.022 MF	50 V	Ceramic
C701	QCF31HP-102	1000 pF	50 V	Ceramic
C801	QCF31HP-223	0.022 MF	50 V	Ceramic
C802	QCF31HP-223	0.022 MF	50 V	Ceramic
C803	QEU51VM-108	1000 MF	35 V	Electro
C804	QET61EM-476	47 MF	25 V	Electro
C805	QET61CM-476	47 MF	16 V	Electro
C806	QET61CM-476	47 MF	16 V	Electro
C807	QET61EM-106	10 MF	25 V	Electro
C808	QET61CM-476	47 MF	16 V	Electro
C901	QCT25CH-101	100 pF	50 V	Ceramic
C902	QCT25CH-101	100 pF	50 V	Ceramic
C903	QET61EM-106	10 MF	25 V	Electro
C904	QET61EM-106	10 MF	25 V	Electro
C905	QCF31HP-223	0.022 MF	50 V	Ceramic

Resistors

Item No.	Parts Number	Description		
R101	QRD141J-332S	3.3 K	1/4 W	Carbon
R102	QRD141J-272S	2.7 K	1/4 W	Carbon
R103	QRD141J-562S	5.6 K	1/4 W	Carbon
R106	QRD141J-104S	100 K	1/4 W	Carbon
R107	QRD141J-102S	1 K	1/4 W	Carbon
R108	QRD141J-183S	18 K	1/4 W	Carbon
R109	QRD141J-102S	1 K	1/4 W	Carbon
R110	QRD141J-102S	1 K	1/4 W	Carbon
R111	QRD141J-102S	1 K	1/4 W	Carbon
R112	QRD141J-124S	120 K	1/4 W	Carbon
R113	QRD141J-103S	10 K	1/4 W	Carbon
R114	QRD141J-103S	10 K	1/4 W	Carbon
R115	QRD141J-103S	10 K	1/4 W	Carbon
R116	QRD141J-393S	39 K	1/4 W	Carbon
R117	QRD141J-333S	33 K	1/4 W	Carbon
R118	QRD141J-183S	18 K	1/4 W	Carbon
R119	QRD141J-473S	47 K	1/4 W	Carbon
R120	QRD141J-473S	47 K	1/4 W	Carbon
R121	QRD141J-333S	33 K	1/4 W	Carbon
R122	QRD141J-333S	33 K	1/4 W	Carbon
R123	QRD141J-103S	10 K	1/4 W	Carbon
R124	QRD141J-333S	33 K	1/4 W	Carbon
R201	ERG3XK-333	33 K		Resistor Array
R202	QRD141J-103S	10 K	1/4 W	Carbon
R203	QRD141J-103S	10 K	1/4 W	Carbon
R204	QRD141J-153S	15 K	1/4 W	Carbon
R205	QRD141J-473S	47 K	1/4 W	Carbon
R206	QRD141J-331S	330	1/4 W	Carbon
R207	QRD141J-122S	1.2 K	1/4 W	Carbon
R208	QRD141J-122S	1.2 K	1/4 W	Carbon
R209	QRD141J-122S	1.2 K	1/4 W	Carbon
R210	QRD141J-122S	1.2 K	1/4 W	Carbon
R212	QRD141J-102S	1 K	1/4 W	Carbon
R214	QRD141J-473S	47 K	1/4 W	Carbon
R215	QRD141J-563S	56 K	1/4 W	Carbon
R217	QRD141J-223S	22 K	1/4 W	Carbon
R218	QRD141J-104S	100 K	1/4 W	Carbon
R219	QRD141J-473S	47 K	1/4 W	Carbon
R251	QRD141J-821S	820	1/4 W	Carbon
R252	QRD141J-821S	820	1/4 W	Carbon
R253	QRD141J-332S	3.3 K	1/4 W	Carbon
R254	QRD141J-473S	47 K	1/4 W	Carbon
R255	QRD141J-473S	47 K	1/4 W	Carbon
R256	QRD141J-332S	3.3 K	1/4 W	Carbon
R257	QRD141J-222S	2.2 K	1/4 W	Carbon
R301	ERGS4XK-333	33 K		Resistor Array
R302	QRD141J-333S	33 K	1/4 W	Carbon
R303	QRD141J-222S	2.2 K	1/4 W	Carbon

△ : Safety Parts

Item No.	Parts Number	Description		
R404	QRD141J-393S	39 K	1/4 W	Carbon
R405	QRD141J-123S	12 K	1/4 W	Carbon
R406	QRD141J-473S	47 K	1/4 W	Carbon
R407	QRD141J-333S	33 K	1/4 W	Carbon
R408	QRD141J-103S	10 K	1/4 W	Carbon
R410	QRD141J-683S	68 K	1/4 W	Carbon
R411	QRD141J-683S	68 K	1/4 W	Carbon
R413	QRD141J-184S	1/4 W		Carbon
R414	QRD141J-103S	10 K	1/4 W	Carbon
R415	QRD141J-103S	10 K	1/4 W	Carbon
R416	QRD141J-103S	10 K	1/4 W	Carbon
R417	QRD141J-822S	8.2 K	1/4 W	Carbon
R418	QRD141J-104S	10 K	1/4 W	Carbon
R419	QRD141J-273S	27 K	1/4 W	Carbon
R420	QRD141J-473S	47 K	1/4 W	Carbon
R421	QRD141J-333S	33 K	1/4 W	Carbon
R422	QRD141J-103S	10 K	1/4 W	Carbon
R424	QRD141J-473S	47 K	1/4 W	Carbon
R430	QRD141J-123S	12 K	1/4 W	Carbon
R431	QRD141J-682S	6.8 K	1/4 W	Carbon
R432	QRD141J-272S	2.7 K	1/4 W	Carbon
R501	QRD141J-333S	33 K	1/4 W	Carbon
R502	QRD141J-102S	1 K	1/4 W	Carbon
R503	QRD141J-333S	33 K	1/4 W	Carbon
R701	QRD141J-223	22 K	1/4 W	Carbon
R702	QRD141J-103S	10 K	1/4 W	Carbon
R703	QRD141J-103S	10 K	1/4 W	Carbon
R704	QRD141J-333S	33 K	1/4 W	Carbon
R705	QRD141J-103S	10 K	1/4 W	Carbon
R706	QRD141J-472S	4.7 K	1/4 W	Carbon
R801	QRD141J-392S	3.9 K	1/4 W	Carbon
R802	QRD141J-181S	180	1/4 W	Carbon
R803	QRZ0062-100	10	1/4 W	Fusible
R804	QRD141J-561S	560	1/4 W	Carbon
R805	QRD141J-333S	33 K	1/4 W	Carbon
R806	QRD141J-223S	22 K	1/4 W	Carbon
R807	QRD141J-473S	47 K	1/4 W	Carbon
R808	QRD141J-473S	47 K	1/4 W	Carbon
R810	QRD141J-101S	100	1/4 W	Carbon
R901	ERGS4XK-103	10 K		Resistor Array
R902	ERGS4XK-333	33 K		Resistor Array
R903	QRD141J-471S	470	1/4 W	Carbon
R904	QRD141J-271S	270	1/4 W	Carbon
R905	QRD141J-271S	270	1/4 W	Carbon
R906	QRD141J-101S	100	1/4 W	Carbon
R907	QRD141J-333S	33 K	1/4 W	Carbon
R908	QRD141J-681S	680	1/4 W	Carbon
R909	QRD141J-103S	10 K	1/4 W	Carbon
R910	QRD141J-122S	1.2 K	1/4 W	Carbon
R911	QRD141J-101S	100	1/4 W	Carbon
R912	QRD141J-151S	150	1/4 W	Carbon
R913	QRD141J-563S	56 K	1/4 W	Carbon
R914	QRD141J-102S	1 K	1/4 W	Carbon
R915	QRD141J-332S	3.3 K	1/4 W	Carbon
R916	QRD141J-333S	33 K	1/4 W	Carbon
R917	QRD141J-333S	33 K	1/4 W	Carbon
VR402	QVP4A0B-223	22 K	0.1 W	Variable
VR501	QVP4A0B-222	2.2 K	0.1 W	Variable
VR502	QVP4A0B-222	2.2 K	0.1 W	Variable

Others

Item No.	Parts Number	Description	Ver.
	E11014-101	Circuit Board	B
	E11014-201	Circuit Board	C
	E11014-201	Circuit Board	D
CP201	EWTO11-076	Terminal Wire	
	ICP-F10	ICP	
P001	QMV5005-010K	10P Plug Ass'y	
P002	QMV5005-005K	5P Plug Ass'y	
P003	QMV5005-004K	4P Plug Ass'y	
P004	QMV5005-008K	8P Plug Ass'y	
P007	QMV5005-003K	3P Plug Ass'y	
P008	QMV5005-006K	6P Plug Ass'y	
SW401	QSS2301-011	Slide Switch	
SW402	QSS2201-012	Slide Switch	
SW801	QSP2256-001	Push Switch	
SW901	ESP0001-007	Push Switch	
SW902	ESP0001-007	Push Switch	
SW903	ESP0001-007	Push Switch	
SW904	ESP0001-007	Push Switch	
SW905	ESP0001-007	Push Switch	
SW906	ESP0001-007	Push Switch	
SW907	ESP0001-007	Push Switch	
SW908	ESP0001-007	Push Switch	
SW908	ESP0001-007	Push Switch	
SW909	ESP0001-007	Push Switch	
SW910	ESP0001-007	Push Switch	
SW911	ESP0001-007	Push Switch	
SW912	ESP0001-007	Push Switch	
SW913	ESP0001-007	Push Switch	
SW914	ESP0001-007	Push Switch	
SW915	ESP0001-007	Push Switch	
SW916	ESP0001-007	Push Switch	
SW917	ESP0001-007	Push Switch	
OS901	ECX0004-190KU	Ceramic Resonator	

Muting P.C. Board Ass'y

Note

The symbols (赤, 黒, 白etc.) on P.C. Board surface are factory process only.

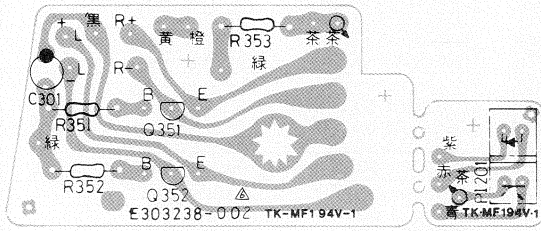

Fig. 7

Item No.	Parts Number	Description
Q351	2SD655(E,F)	Transistor
Q352	2SD655(E,F)	Transistor
	SLR-54DU32	L.E.D.
	QET51HM-475	Electrolytic Capacitor
		4.7MF 50 V
R351	QRD148J-222S	Carbon Resistor
		2.2 K 1/4 W
R352	QRD148J-222S	Carbon Resistor
		2.2 K 1/4 W
R353	QRD148J-102S	Carbon Resistor
		1 K 1/4 W
	E303238-002	Circuit Board
	TLP801A-V	Interruptor
	E71088-001	Signal Cord Ass'y
	EWP203-009	Cord Ass'y
	E70831-001	Circuit Board

Sensor P.C. Board Ass'y

Note

The symbols (赤, 黒, 白etc.) on P.C. Board surface are factory process only.

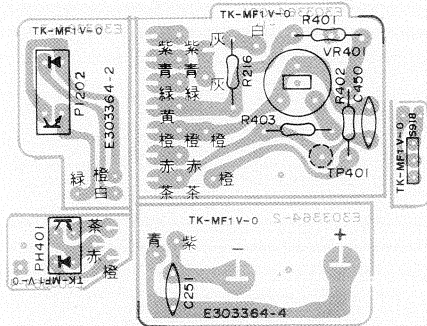

Fig. 8

Item	Part Number	Description
C251	QCF21HP-102	Ceramic Capacitor
		1000pF 50 V
C450	QCF21HP-102	Ceramic Capacitor
		1000 pF 50 V
	QRD148J-221	Carbon Resistor
		220 1/4 W
	QRD148J-271	Carbon Resistor
		270 1/4 W
	QRD148J-103	Carbon Resistor
		10 K 1/4 W
VR401	QVP4A0B-224	Variable
		220 K 0.1 W
PH401	RPR-358	Interruptor
PI202	TLP801A-V	Interruptor
S918	QSS1201-034	Slide Switch
	EWP202-011	Signal Cord
	E43727-002	Tab
	E303364-001	Circuit Board
	EWP203-008	Cord Ass'y

Signal P.C. Board Ass'y

Note

The symbols (赤, 黒, 白etc.) on P.C. Board surface are factory process only.

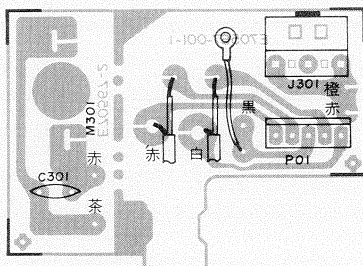

Fig. 9

Item	Part Number	Description
C301	QEN51HM-225	2.2 MF 50 V Non Pole Capacitor
J301	QMS3533-001	Jack
P01	QMV5004-005	5P Plug Ass'y
M301	E300763-005	Motor
	E71219-001	Sheeld Bracket
	E61215-001	P.C. Board

Packing Materials and Part Numbers

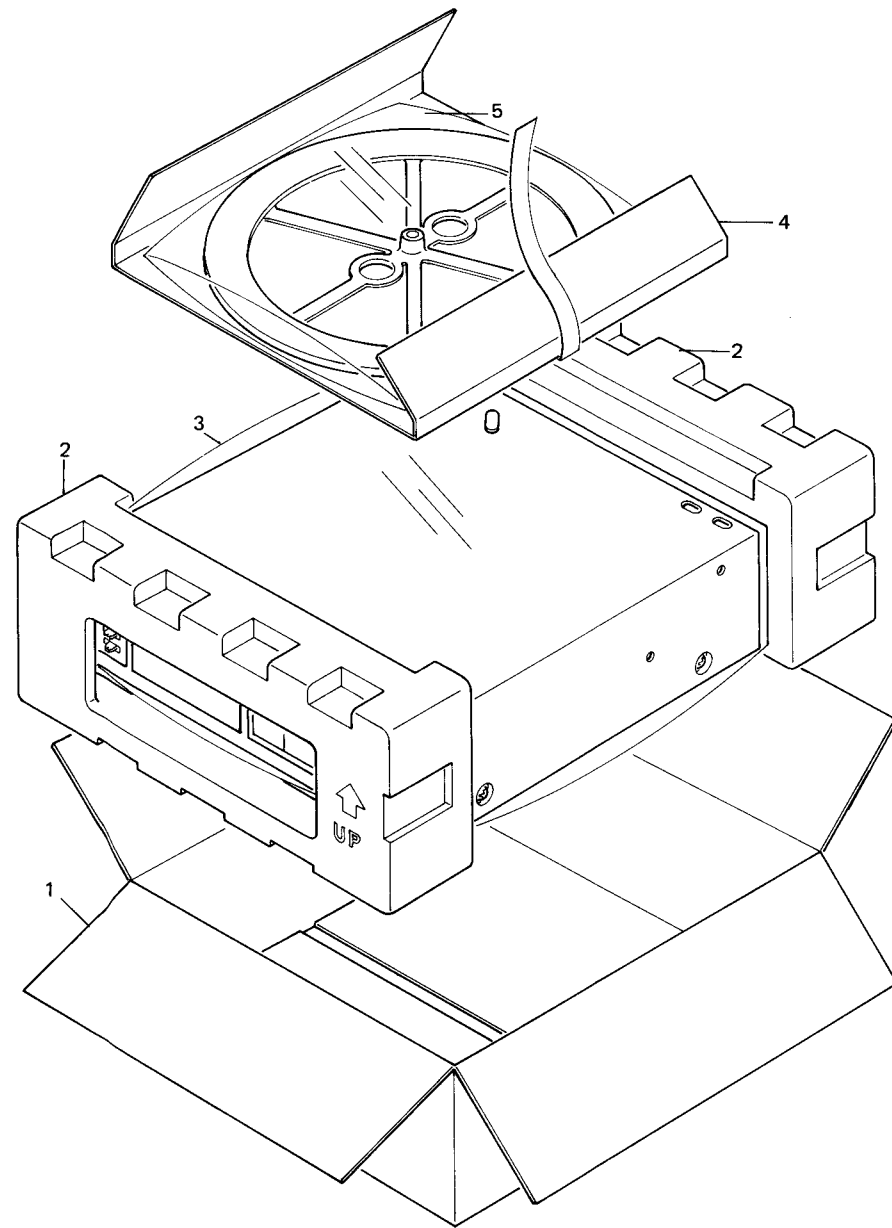

Fig. 10

The Marks for Designated Areas.

J	U.S.A.
C	Canada
E	Europe
G	West Germany
ES	Spain
P,PG	U.S.Military Market
BS	U.K.
A	Australia
U	Other Countries
No mark	All areas.

No.	Part Number	Part Name	Q'ty	Description	Area
1	PK-LE50E (B)	Packing Case	1	E24775-003	
2	PK-LE50ES	Packing Case	1	E24775-004	ES
	NZ-LE50	Fillers	1	E24601-001	
3	E300196-031	Envelope	1		
	E300196-031B	Envelope	1		BS
4	E303152-001	Sheet	1		
5	E300196-039	Envelope	1		
	E300196-039B	Envelope	1		BS
	E35497-017	Caution Sheet	1	110 V	P
	E35497-019	Caution Sheet	1	220 V	U,PG
	E35246-001	Serial Label	1		J,C,U,P,PG,A
	E35246-004	Serial Label	1		E,ES
	E35246-006	Serial Label	1		G

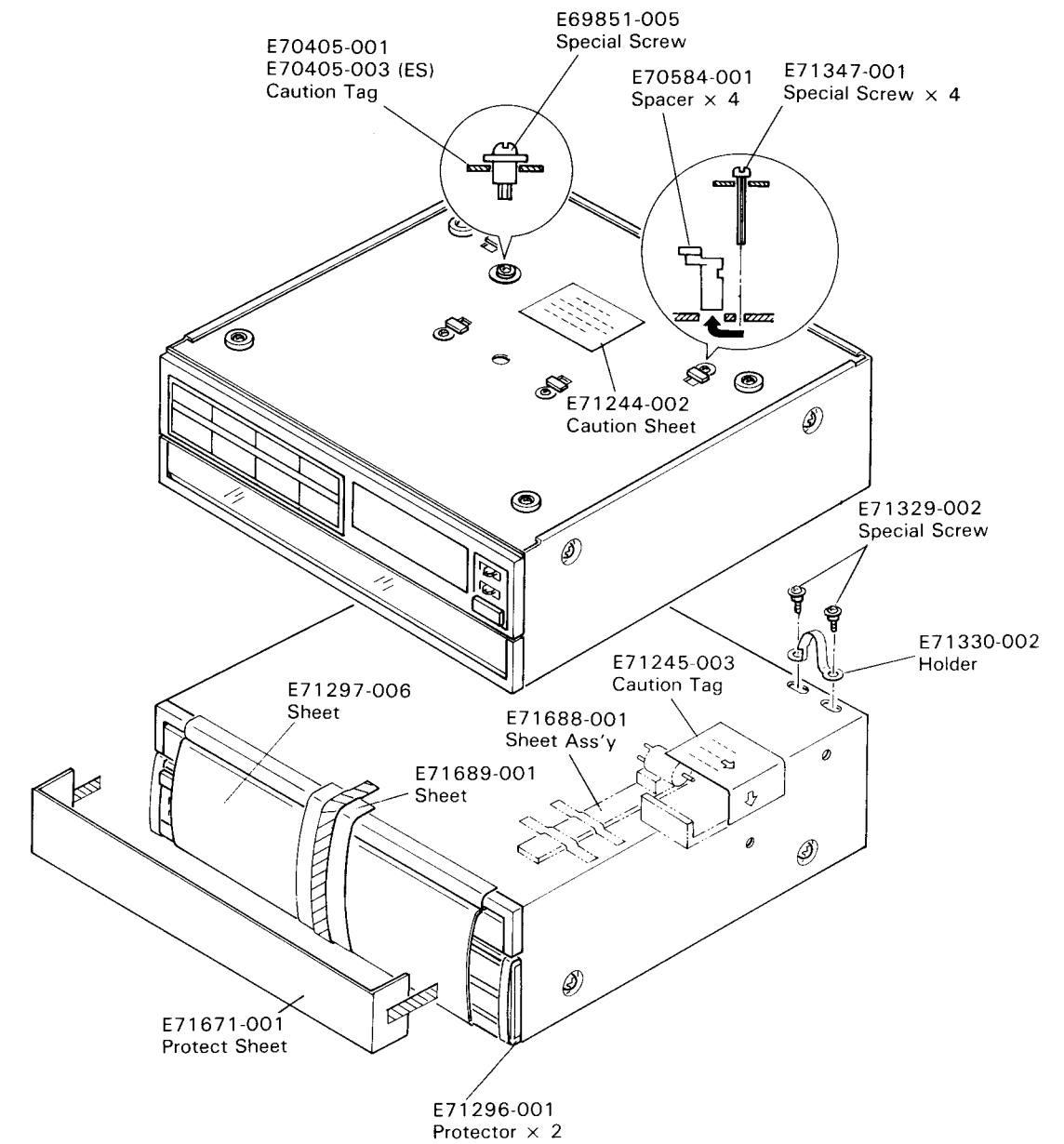

Fig. 11

Accessories List

Part Number	Part Name	Description	Areas
E30580-1198A E30580-1198ABS BT20047A BT20025H BT20047A	Instruction Book Instruction Book Warranty Card Warranty Card Warranty Card		J,C,U,P,PG,E,A,G,ES BS J C P,PG
BT20029C BT20060 BT20064 BT20071 BT20046B	Warranty Card Warranty Card Warranty Card SVC Center List Service Information Card		A BS G C J,P,PG
BT20044D BT20066 E303495-001 E35497-019 E35497-017	Service Information Sheet EEC Agency Caution Sheet Caution Sheet Caution Sheet		J BS,G U,PG P
E04056 E66329-001 EWP805-001 E66416-003 E71090-001	Siemens Plug EP Adaptor 1P Plug Cord Envelope Cap	for Warranty Card	U,PG J
E300196-010 E300196-010B	Envelope Envelope		BS

The Marks for Designated Areas.			
J	U.S.A.	P,PG	U.S.Military Market
C	Canada	ES	Spain
E	Europe	BS	U.K.
G	West Germany	U	Other Countries
A	Australia	No mark	All areas